

ENGINEERED BY SYNRAD

vi Series Lasers

Operator's Manual

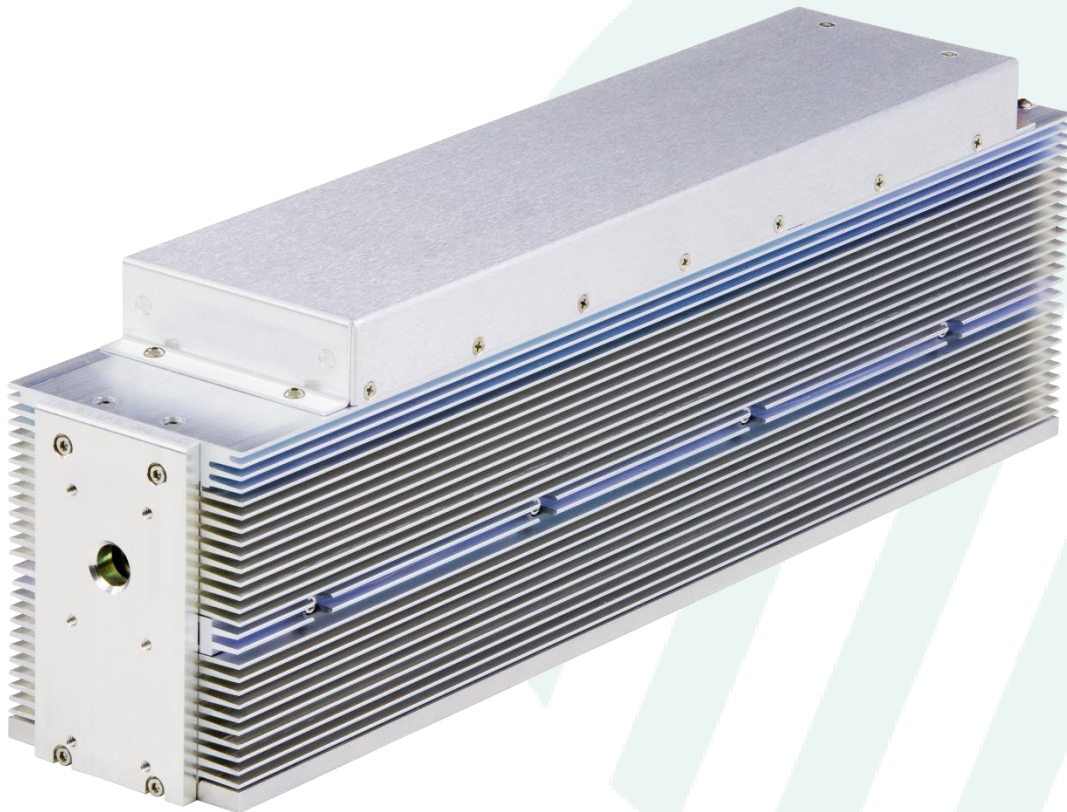

Contents

1	General Information	7
1.1	Trademark & Copywrite	7
1.2	Warranty Information	7
1.3	Contact Information	8
1.3.1	Online Contact Form	8
1.3.2	Americas, Asia Pacific	8
1.3.3	Europe, Middle East, Africa	9
1.3.4	China	9
1.3.5	Japan	9
1.4	Application Testing	9
1.5	General Inquiries	10
1.6	Technical Support	10
1.7	Reference Materials	10
2	Laser Safety	11
2.1	Hazard Information	11
2.1.1	Terms	11
2.1.2	General Hazards	11
2.1.3	Other Hazards	14
2.1.4	Disposal	14
2.1.5	Additional Laser Safety Information	14
2.2	Label Locations	15
2.2.1	Figure: vi30 Laser Label Locations	15
2.2.2	Figure: vi40 Laser Label Locations	16
2.3	Agency Compliance	16
2.3.1	Center for Devices and Radiological Health (CDRH) Requirements	17
2.3.2	Table: Class 4 Safety Features Required by CDRH & EN60825-1	18
2.3.3	Federal Communications Commission (FCC) Requirements	19
2.3.3.1	FCC Information	20
2.3.4	European Union (EU) Requirements	20

2.3.4.1	RoHS Compliance	20
2.3.4.2	Laser Safety Standards	21
2.3.4.3	Electromagnetic Interference Standards	21
2.3.4.4	Table: European Union Directives	22
2.3.5	vi30 Declaration of Conformity	23
2.3.6	vi40 Declaration of Conformity	24
3	Getting Started	25
3.1	Introduction	25
3.1.1	Nomenclature	25
3.1.2	Figure: Decoding Part Numbers	26
3.2	Unpacking	26
3.2.1	Incoming Inspection	26
3.2.2	Packaging Guidelines	26
3.2.2.1	Repackaging or Storing	27
3.2.3	Table: vi Series Shipment Inventory	28
3.3	Mounting	28
3.3.1	Mounting the vi Series Laser	29
3.3.1.1	Figure: vi30 Mounting Locations	29
3.3.2	Optional Mounting Feet	30
3.3.2.1	Figure: Tall and Tall/Wide Mounting Feet	31
3.3.2.2	Install the optional mounting feet	31
3.4	Cooling	31
3.4.1	Air Cooling	32
3.4.1.1	Side Cooling	32
3.4.1.2	Figure: Cooling Fan Locations (Side)	33
3.4.1.3	Rear Cooling	33
3.4.1.4	Figure: Alternate vi30 Cooling Fan (Rear)	34
3.4.2	Water Cooling	34
3.4.2.1	Cooling Fitting Adaptors	34
3.4.2.2	Cutting and Installing Tubing	34
3.4.2.3	Chiller Preparation	35
3.4.2.4	Coolants	35

3.4.2.5	Setting Coolant Temperature _____	36
3.4.2.6	Table: Dew Point Temperatures _____	37
3.4.2.7	Cooling Tubing Connections _____	38
3.4.3	Temperature Monitoring _____	38
3.4.3.1	Figure: vi30 External Temperature Monitoring Location _____	39
3.5	Electrical Connections _____	39
3.5.1	DC Power Supply _____	39
3.5.2	Control Connections _____	40
3.5.2.1	UC-2000 Universal Laser Controller _____	40
3.6	Controls and Indicators _____	42
3.6.1	Front Panel _____	42
3.6.2	Figure: Front Panel _____	42
3.6.3	Rear Panel _____	43
3.6.4	Figure: Rear Panel _____	44
3.7	Initial Start-Up _____	44
3.7.1	Status Indicators _____	44
3.7.2	With a UC-2000 Controller _____	45
3.7.3	Without a UC-2000 Controller _____	46
4	Technical Reference _____	48
4.1	Technical Overview _____	48
4.1.1	vi Series Laser Design _____	48
4.1.1.1	Laser Tube _____	48
4.1.1.2	Optical Resonator _____	48
4.1.1.3	Figure: vi Series Beam Ellipticity _____	49
4.1.1.4	Internal RF Power Supply _____	49
4.1.1.5	Control Circuit _____	49
4.1.2	Optical Setup _____	50
4.1.2.1	Beam Delivery Optics _____	50
4.1.2.2	Focusing Optics _____	50
4.1.2.3	Table: Assist Gas Purity Specifications _____	51
4.2	Controlling Laser Power _____	51
4.2.1	Control Signals _____	51

4.2.1.1	Tickle Pulses	52
4.2.1.2	Pulse Width Modulation (PWM)	52
4.2.1.3	Figure: Typical Optical Output Pulse (50%) Duty Cycle at 3 kHz	53
4.2.1.4	Figure: Typical Optical Output Pulse (50%) Duty Cycle at 5 kHz	53
4.2.1.5	Command Signal	53
4.2.1.6	Figure: PWM Command Signal Waveform	54
4.2.1.7	Table: PWM Command Signal Levels	55
4.2.2	Operating Modes	55
4.2.2.1	External Control	55
4.2.2.2	Analog Voltage or Current Control	55
4.2.2.3	Continuous Wave (CW) Operation	56
4.2.2.4	Gated Operation	56
4.3	DB-9 I/O Connections	57
4.3.1	DB-9 I/O Connector	57
4.3.1.1	Figure: DB-9 I/O Connector Pinouts	57
4.3.1.2	Table: DB-9 I/O Pin Descriptions	58
4.3.2	Input Circuitry	59
4.3.2.1	Figure: Input Equivalent Schematic	59
4.3.2.2	Table: Input Circuit Specifications	59
4.3.2.3	Sample Input Circuits	60
4.3.2.3.1	Figure: vi30 Powered Laser Enable Circuit	60
4.3.2.3.2	Figure: Customer Powered Laser Enable Circuit	61
4.3.2.3.3	Figure: PLC Switched Laser Enable Circuit	61
4.3.3	Output Circuitry	61
4.3.3.1	Table: Output Circuit Specifications	62
4.3.3.2	Figure: Output Equivalent Schematic	62
4.3.3.3	Sample Output Circuit	63
4.3.3.4	Figure: Laser Indicator Output to PLC Input	63
4.3.4	vi40 Temperature Broadcast	63
4.3.4.1	Synchronous Data Transmission	63
4.3.4.2	Figure: Synchronous Transmission of a Single Bit	64
4.3.4.3	Figure: Rest Period	64
4.3.4.4	Temperature Reading	64
4.3.4.5	Figure: Example Output for Measurement of 25.5°C	65

4.3.4.6	Table: Example Temperature Measurements _____	65
4.4	General Specifications _____	66
4.4.1	vi Series General Specifications _____	66
4.5	Outline & Mounting Drawings _____	68
4.5.1	Figure: vi30 Air-Cooled (OEM) Outline and Mounting Dimensions _____	68
4.5.1.1	Figure: vi30 Outline and Mounting Dimensions – with Optional Customer-Installed “Tall” Mounting Feet _____	69
4.5.1.2	Figure: vi30 Outline and Mounting Dimensions – with Optional Customer-Installed “Tall/Wide” Mounting Feet _____	70
4.5.2	Figure: vi30 Water-Cooled Outline and Mounting Dimensions _____	71
4.5.3	Figure: vi40 Air-Cooled Outline and Mounting Dimensions _____	72
4.5.4	Figure: vi Series Packaging Instructions _____	73
5	Maintenance and Troubleshooting _____	74
5.1	Maintenance _____	74
5.1.1	Disabling the Laser _____	74
5.1.2	Daily Inspections _____	74
5.1.3	Storage/Shipping _____	75
5.1.4	Cleaning Optical Components _____	75
5.1.4.1	Cleaning Guidelines _____	76
5.1.4.2	Table: Required Cleaning Materials _____	77
5.1.4.3	Cleaning Optics _____	77
5.2	Troubleshooting _____	78
5.2.1	Introduction _____	78
5.2.2	Figure: Operational Flowchart _____	80
5.2.3	Status Indicator LEDs _____	81
5.2.4	Laser Fault Indicators _____	81
5.2.5	Table: vi Series Input I/O Status States _____	82
5.2.6	Resetting Faults _____	83
5.2.6.1	Over Temperature Fault _____	83
5.2.6.2	Under Voltage Fault _____	83
5.2.6.3	Over Voltage Fault _____	83
5.2.6.4	DC Sense Fault _____	83
5.2.6.5	PWM Sense / Control Board Fault _____	83

5.2.7	Other Laser Faults _____	84
5.2.8	Beam Delivery Optics _____	87

1 General Information

For your protection, carefully read these instructions before installing and operating the laser.

Retain these instructions for future reference.

Novanta reserves the right to update this user manual at any time without prior notification.

If product ownership changes, this manual should accompany the product.

1.1 Trademark & Copywrite

Novanta and vi Series lasers are registered trademarks of Novanta.

All other trademarks or registered trademarks are the property of their respective owners.

© 2025 by Novanta.

All rights reserved.

1.2 Warranty Information

This is to certify that vi Series lasers are guaranteed by Novanta to be free of all defects in materials and workmanship for the period defined in the Novanta Terms and Conditions, as defined on the Novanta website: <https://novanta.com/terms/novanta-sales-terms-and-conditions/>

This warranty does not apply to any defects caused by negligence, misuse (including environmental factors), accident, alteration, or im-proper maintenance. We request that you examine each shipment within 10 days of receipt and inform Novanta of any shortage or damage. If no discrepancies are reported, Novanta shall assume the shipment was delivered complete and defect-free.

If, within the warranty period, any part of the laser should fail to operate, contact the Novanta CO2 Laser Customer Care department using the Service Request form on the website (<https://novantaphotonics.com/service-request-form-header/>) or by emailing co2lasercustomer@novanta.com . When requesting support, please provide the date of purchase, model number and serial number of the unit, and a brief description of the problem.

When returning a unit for service, a Return Authorization (RA) number is required; this number must be clearly marked on the outside of the shipping container for the unit to be properly processed. If replacement parts are sent to you, then you are required to send the failed parts back to Novanta for evaluation unless otherwise instructed.

If your vi Series laser fails within the first 45 days after purchase, Novanta will pay all shipping charges to and from Novanta when shipped as specified by Novanta Customer Service. After the first 45 days,

Novanta will continue to pay for the costs of shipping the repaired unit or replacement parts back to the customer from Novanta. The customer, however, will be responsible for shipping charges incurred when sending the failed unit or parts back to Novanta or a Novanta Authorized Distributor. To maintain your product warranty and to ensure the safe and efficient operation of your vi Series laser, only authorized Novanta replacement parts can be used. This warranty is void if any parts other than those provided by Novanta are used.

Novanta and Novanta Authorized Distributors have the sole authority to make warranty statements regarding Novanta products. Novanta and its Authorized Distributors neither assumes nor authorizes any representative or other person to assume for us any other warranties in connection with the sale, service, or shipment of our products. Novanta reserves the right to make changes and improvements in the design of our products at any time without incurring any obligation to make equivalent changes in products previously manufactured or shipped. Buyer agrees to hold Novanta harmless from all damages, costs, and expenses relating to any claim arising from the design, manufacture, or use of the product, or arising from a claim that such product furnished Buyer by Novanta, or the use thereof, infringes upon any Patent, foreign or domestic.

1.3 Contact Information

The CO2 laser business (SYNRAD) is headquartered north of Seattle in Mukilteo, Washington, U.S.A. Our mailing address is:

Novanta
4600 Campus Place
Mukilteo, WA 98275
U.S.A.

The fastest way to contact us is using the online contact us form. You can also call one of our global offices. See the following sections for more information.

1.3.1 Online Contact Form

For the fastest response, please fill out a request form on our website:

<https://novantaphotonics.com/contact-us/>

1.3.2 Americas, Asia Pacific

Novanta Headquarters, Bedford, USA

Phone: +1-781-266-5700

co2lasercustomercare@novanta.com

1.3.3 Europe, Middle East, Africa

Novanta Europe GmbH, Wackersdorf, Germany

Phone: +49 9431 7984-0

sales-europe@novanta.com

Milan, Italy

Phone: +39-039-793-710

1.3.4 China

Novanta Sales & Service Office, Shenzhen, China

Phone: +86-755-8280-5395

Novanta Sales & Service Office, Suzhou, China

Phone: +86-512-6283-7080

1.3.5 Japan

Novanta Service & Sales Office, Tokyo, Japan

Phone: +81-3-5753-2460

1.4 Application Testing

Novanta Regional Sales Managers work with customers to identify and develop the best CO2 laser solution for a given application. Because they are familiar with you and your laser application, use them as a first point of contact when questions arise. Regional Sales Managers also serve as the liaison between you and our Applications Lab in processing material samples per your specifications.

To speak to the Regional Sales Manager in your area, utilize the contact information listed above.

You can also use the Application Test Request form on our website:

<https://novantaphotonics.com/application-test-request-form-header/>

1.5 General Inquiries

For assistance with order or delivery status or service status, please use the Information Request form on our website: <https://novantaphotonics.com/info-request-form-header/>

To obtain a Return Authorization (RA) number, please use the Service Request form on our website:

<https://novantaphotonics.com/service-request-form-header/>

For all other inquiries, please contact our Customer Care team by emailing

co2lasercustomercare@novanta.com .

1.6 Technical Support

Novanta Regional Sales Managers can answer many technical questions regarding the installation, use, troubleshooting, and maintenance of our products. In some cases, they may transfer your call to a Laser, Marking Head, or Software Support Specialist.

You may also submit questions using the Technical Support Request form on our website

(<https://novantaphotonics.com/technical-support-request-form-header/>) or by sending an email to

co2lasercustomercare@novanta.com .

1.7 Reference Materials

Your Regional Sales Manager can provide reference materials including Outline & Mounting drawings, Operator's Manuals, Technical Bulletins, and Application Newsletters.

Additional reference information can be found online in our resource hub:

<https://novantaphotonics.com/the-resource-hub/>



2 Laser Safety

2.1 Hazard Information

Hazard information includes terms, symbols, and instructions used in this manual or on the equipment to alert both operating and service personnel to the recommended precautions in the care, use, and handling of Class 4 laser equipment.

2.1.1 Terms

Certain terms are used throughout this manual or on the equipment labels. Please familiarize yourself with their definitions and significance.

-  **Danger** : Imminent hazards which, if not avoided, could result in death or serious injury.
-  **Warning** : Potential hazards which, if not avoided, could result in death or serious injury.
-  **Caution** : Potential hazards or unsafe practices which, if not avoided, may result in moderate or minor injury.
- **Caution**: Potential hazards or unsafe practices which, if not avoided, may result in product damage.
- **Important note**: Important information or recommendations concerning the subject under discussion.
- **Note**: Points of particular interest for more efficient or convenient equipment operation; additional information or explanation concerning the subject under discussion.

2.1.2 General Hazards

Following are descriptions of general hazards and unsafe practices that could result in death, severe injury, or product damage. Specific warnings and cautions not appearing in this section are found throughout the manual.

**Danger: Serious Personal Injury**

This Class 4 laser product emits **invisible** infrared laser radiation in the 9.3 – 10.6 μm CO₂ wavelength band, depending on model.

Do not allow laser radiation to enter the eye by viewing direct or reflected laser energy. CO₂ laser radiation can be reflected from metallic objects even though the surface is darkened. Direct or diffuse laser radiation can inflict severe corneal injuries leading to permanent eye damage or blindness. All personnel must wear eye protection suitable for 9.3 – 10.6 μm CO₂ radiation when in the same area as an exposed laser beam. Eyewear protects against scattered energy but is not intended to protect against direct viewing of the beam – never look directly into the laser output aperture or view scattered laser reflections from metallic surfaces.

Enclose the beam path wherever possible. Exposure to direct or diffuse CO₂ laser radiation can seriously burn human or animal tissue, which may cause permanent damage.

Always wear safety glasses or protective goggles with side shields to reduce the risk of damage to the eyes when operating the laser.

**Danger: Serious Personal Injury**

This product is not intended for use in explosive, or potentially explosive, atmospheres.

**Warning: Serious Personal Injury**

For laser systems being used or sold within the U.S.A., customers should refer to and follow the laser safety precautions described American National Standards Institute (ANSI) document Z136.1-2014, *Safe Use of Lasers*.

For laser systems being used or sold outside the U.S.A., customers should refer to and follow the laser safety precautions described in European Normative and International Electrotechnical Commission documents IEC/ TR 60825-14:2014, *Safety of Laser Products – Part 14: A User's Guide*.

**Warning: Serious Personal Injury**

Materials processing with a laser can generate air contaminants such as vapors, fumes, and/or particles that may be noxious, toxic, or even fatal. Material Safety Data Sheets (MSDS) for materials being processed should be thoroughly evaluated and the adequacy of provisions for fume extraction, filtering, and venting should be carefully considered. Review the following references for further information on exposure criteria:

ANSI Z136.1-2014, *Safe Use of Lasers*, section 7.3.

U.S. Government's *Code of Federal Regulations*: 29 CFR §1910, §§ Z.

Threshold Limit Values (TLV's) published by the American Conference of Governmental Industrial Hygienists (ACGIH).

It may be necessary to consult with local governmental agencies regarding restrictions on the venting of processing vapors.

**Warning: Serious Personal Injury**

The use of controls or adjustments or performance of procedures other than those specified herein may result in hazardous radiation exposure.

**Warning: Serious Personal Injury**

The use of aerosol dusters containing difluoroethane causes "blooming," a condition that significantly expands and scatters the laser beam. This beam expansion can affect mode quality and/or cause laser energy to extend beyond the confines of optical elements in the system, damaging acrylic safety shielding. Do not use air dusters containing difluoroethane in any area adjacent to CO₂ laser systems because difluoroethane persists for long time periods over wide areas.

Lasers should be installed and operated in manufacturing or laboratory facilities by trained personnel only. Due to the considerable risks and hazards associated with the installation and operational use of any equipment incorporating a laser, the operator must follow product warning labels and instructions to the user regarding laser safety.

To prevent exposure to direct or scattered laser radiation, follow all safety precautions specified throughout this manual and exercise safe operating practices per ANSI Z136.1-2014, *Safe Use of Lasers* always when actively lasing. Always wear safety glasses or protective goggles with side shields to reduce the risk of damage to the eyes when operating the laser.

A CO₂ laser is an intense energy source and will ignite most materials under the proper conditions. Never operate the laser in the presence of flammable or explosive materials, gases, liquids, or vapors.

The use of controls or adjustments or performance of procedures other than those specified herein may result in exposure to invisible laser radiation, damage to, or malfunction of the laser. Severe burns will result from exposure to the laser beam.

Safe operation of the laser requires the use of an external beam block to safely block the beam from traveling beyond the desired work area. Do not place your body or any combustible object in the path of the laser beam. Use a water-cooled beam dump or power meter, or similar non-scattering, noncombustible material as the beam block. Never use organic material or metals as the beam blocker; organic materials, in general, are apt to combust or melt and metals act as specular reflectors which may create a serious hazard outside the immediate work area.

2.1.3 Other Hazards

The following hazards are typical for this product family when incorporated for intended use:

- (A) risk of injury when lifting or moving the unit;
- (B) risk of exposure to hazardous laser energy through unauthorized removal of access panels, doors, or protective barriers;
- (C) risk of exposure to hazardous laser energy and injury due to failure of personnel to use proper eye protection and/or failure to adhere to applicable laser safety procedures;
- (D) risk of exposure to hazardous or lethal voltages through unauthorized removal of covers, doors, or access panels;
- (E) generation of hazardous air contaminants that may be noxious, toxic, or even fatal.

2.1.4 Disposal

This product contains components that are considered hazardous industrial waste. If a situation occurs where the laser is rendered non-functional and cannot be repaired, it may be returned to Novanta who, for a fee, will ensure adequate disassembly, recycling and/or disposal of the product.

2.1.5 Additional Laser Safety Information

The Occupational Safety and Health Administration (OSHA) provides an online Technical Manual located at <https://www.osha.gov/otm>. Section III, Chapter 6 and Appendix III are useful resources for laser safety information.

Another excellent laser safety resource is the Laser Institute of America (LIA). Their comprehensive web site is located at <http://www.lia.org>.

2.2 Label Locations

2.2.1 Figure: vi30 Laser Label Locations

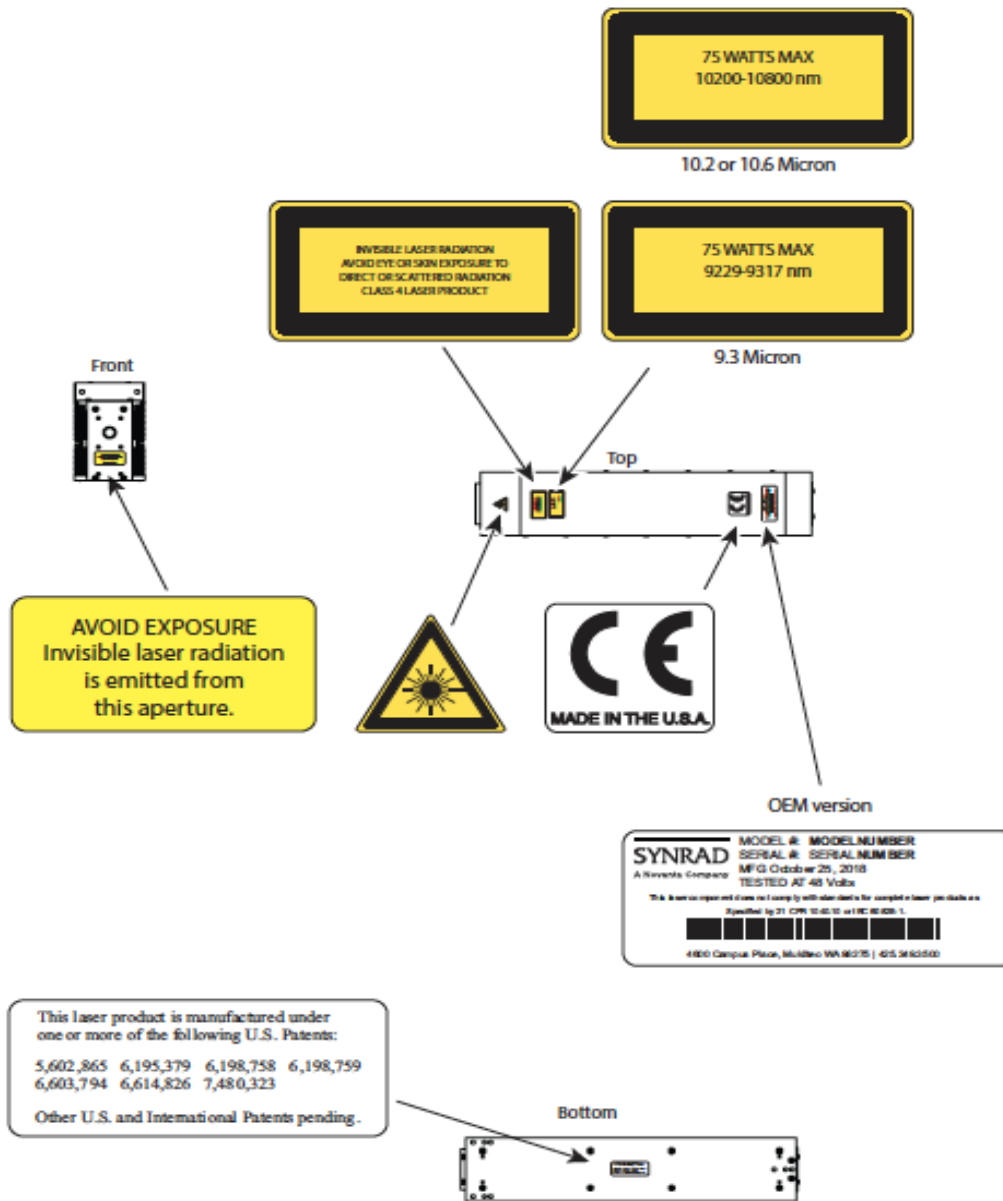

2.2.2 Figure: vi40 Laser Label Locations

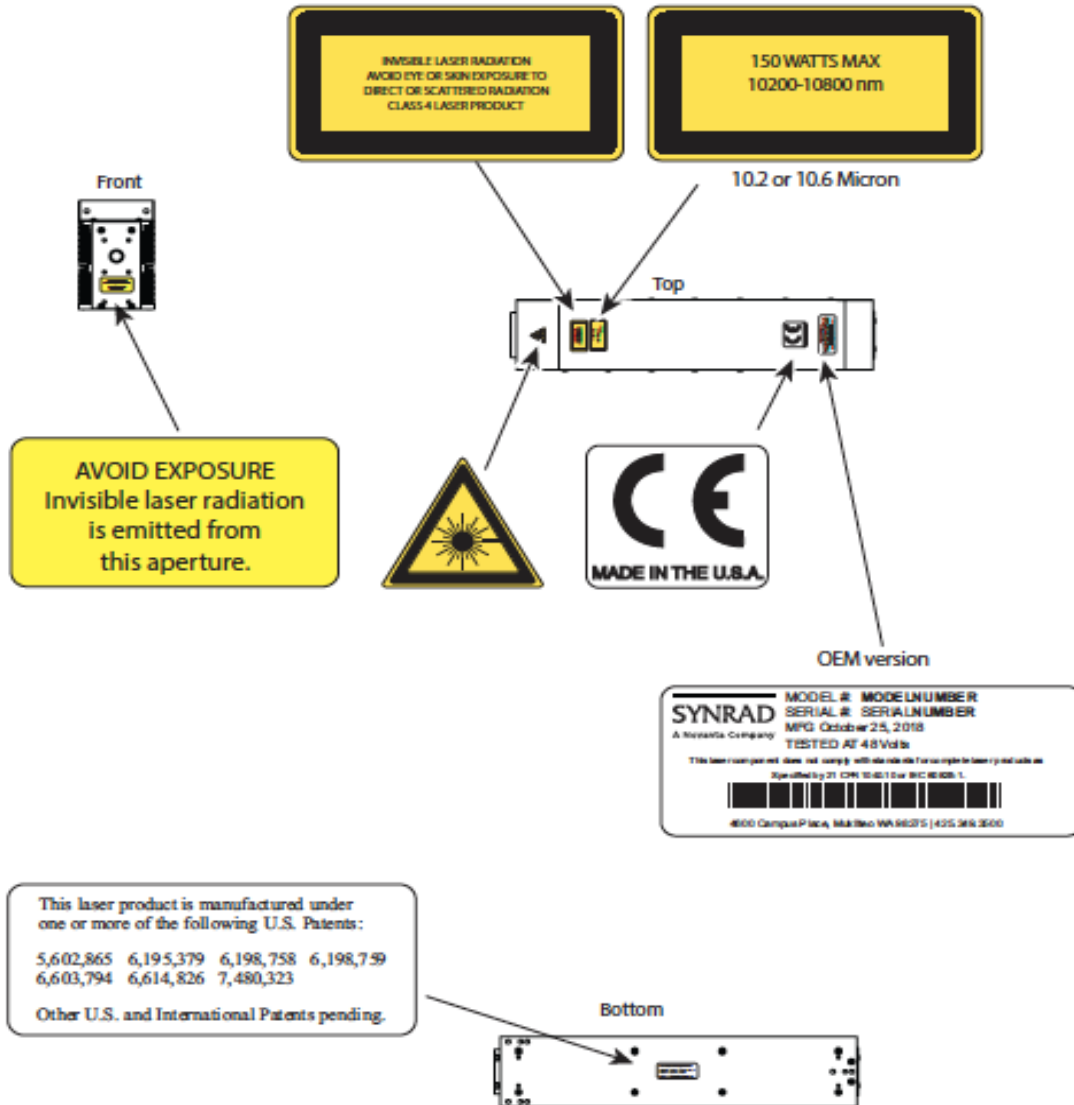

2.3 Agency Compliance

Novanta lasers are designed, tested, and certified to comply with certain United States (U.S.) and European Union (EU) regulations. These regulations impose product performance requirements related to electromagnetic compatibility (EMC) and product safety characteristics for industrial, scientific, and medical (ISM) equipment. The specific provisions to which systems containing vi Series lasers must comply are identified and described in the following paragraphs.

In the U.S., laser safety requirements are governed by the Center for Devices and Radiological Health (CDRH) under the auspices of the U.S. Food and Drug Administration (FDA) while radiated emission standards fall under the authority of the U.S. Federal Communications Commission (FCC). Outside the U.S., laser safety and emissions are governed by European Union (EU) Directives and Standards.

In the matter of CE-compliant laser products, Novanta assumes no responsibility for the compliance of the system into which the product is integrated, other than to supply and/or recommend laser components that are CE marked for compliance with applicable European Union Directives.

Because OEM laser products are intended for incorporation as components in a laser processing system, they do not meet all the Standards for complete laser processing systems as specified by 21 CFR, Part 1040 or EN 60825-1. Novanta assumes no responsibility for the compliance of the system into which OEM laser products are integrated.

2.3.1 Center for Devices and Radiological Health (CDRH) Requirements

The vi Series lasers are OEM products intended for incorporation as components in laser processing systems. As supplied by Novanta, these lasers do not meet the requirements of 21 CFR, Subchapter J without additional safeguards. In the U.S., the Buyer of these OEM laser components is solely responsible for the assurance that the laser processing system sold to an end user complies with all laser safety requirements before the actual sale of the system. Under CDRH regulations, the Buyer must submit a report to the CDRH prior to shipping the system. In jurisdictions outside the U.S., it is the sole responsibility of the Buyer of these OEM components to ensure that they meet all applicable local laser safety requirements.

In cases where the Buyer is also the end-user of the OEM laser product, the Buyer/end-user must integrate the laser so that it complies with all applicable laser safety standards as set forth above.

There are features incorporated into the design of vi Series lasers to comply with CDRH requirements. The features are integrated as panel controls or indicators, internal circuit elements, or input/output signal interfaces. Specifically, these features include a lase and laser ready indicators, remote interlock for power on/off, a laser aperture shutter switch, and a five-second delay between power on and lasing.

Incorporation of certain features is dependent on the laser version (Keyswitch or OEM). See 2.3.2 *Table: Class 4 Safety Features Required by CDRH & EN60825* for the features available on vi Series lasers, the type and description of the feature, and if the feature is required by CDRH regulations.

2.3.2 Table: Class 4 Safety Features Required by CDRH & EN60825-1

Feature	Location	Description	Required by:		Available on OEM vi Series
			CDRH	EN60825-1	
Keyswitch ¹	Rear Panel Control	On/Off/Reset Key switch controls power to laser electronics. Key cannot be removed from switch in the "On" position.	Yes	Yes	No
Shutter Function ¹	Laser Control	Functions as a beam attenuator to disable RF driver/laser output when closed.	Yes	Yes	No
Shutter Function ¹ (SHT)	Rear Panel Indicator (Blue)	Functions as a beam attenuator to disable RF driver/laser output when closed.	Yes	Yes	No
PWR (power) indicator	Rear Panel Indicator (Green)	Illuminates green to indicate DC power is applied.	No	No	Yes
Ready Indicator (RDY)	Rear Panel Indicator (Yellow)	Indicates that laser has power applied and is capable of lasing.	Yes	Yes	Yes
Lase Indicator	Rear panel indicator (Red)	Indicates that laser is actively lasing. Lase LED illuminates when the duty cycle of the command cycle is long enough to produce laser output.	No	No	Yes
Five second delay	Circuit Element	Disables RF driver/laser output for five seconds after Keyswitch is turned to "On" or remote reset/start pulse is applied when Keyswitch is in "On" position.	Yes	No	No
Power Fail Lockout ¹	Circuit Element	Disables RF driver/laser output if input power is removed then later reapplied (AC power failure or remote interlock actuation) while Keyswitch is in "On" position	Yes	Yes	No
Remote Interlock	Rear Panel Connection	(Laser Enable Input) Disables RF driver/laser output when a remote interlock switch on an equipment door or panel is opened.	Yes	Yes	Yes

Remote Interlock INT Indicator	Rear panel indicator (Green/Red)	Illuminates green when Remote Interlock circuitry is closed. Illuminates red when interlock circuitry is open.	No	No	Yes
Over Temperature Protection	Circuit Element	Temperature shutdown occurs if temperature of the laser tube rises above safe operating limits	No	No	Yes
Temp (TMP) indicator	Rear panel indicator (Green/Red)	Red when thermal limit exceed. Green when temp within limits	No	No	Yes
Warning Labels	Laser exterior	Labels attached to various external housing locations to warn personnel of potential laser hazards.	Yes	Yes	Yes

¹ Not available nor required on vi Series OEM lasers.

When integrating Novanta vi30 OEM lasers, the Buyer and/or integrator of the end system is responsible for meeting all applicable Standards to obtain the CE mark. To aid this compliance process, Novanta testing program has demonstrated that vi30 lasers comply with the relevant requirements of Directive 2014/30/EU, the Electromagnetic Compatibility Directive, as summarized in 2.3.4.1 European Union Directives Table.

2.3.3 Federal Communications Commission (FCC) Requirements

The United States Communication Act of 1934 vested the Federal Communications Commission (FCC) with the authority to regulate equipment that emits electromagnetic radiation in the radio frequency spectrum. The purpose of the Communication Act is to prevent harmful electromagnetic interference (EMI) from affecting authorized radio communication services. The FCC regulations that govern industrial, scientific, and medical (ISM) equipment are fully described in 47 CFR, Part 18, Subpart C.

Novanta vi Series lasers have been tested and found to comply by demonstrating performance characteristics that have met or exceeded the requirements of 47 CFR, Part 18, Subpart C for Radiated and Conducted Emissions.

2.3.3.1 FCC Information

Note:

The following FCC information for the user is provided to comply with the requirements of 47 CFR, Part 18, Section 213.

Interference Potential

In our testing, Novanta has not discovered any significant electrical interference traceable to vi Series lasers.

System Maintenance

Ensure that all exterior covers are properly fastened in position.

Measures to Correct Interference

If you suspect that your laser interferes with other equipment, take the following steps to minimize this interference:

1. Use shielded cables to and from the equipment that is experiencing interference problems.
2. Ensure that the laser is properly grounded to the same electrical potential as the equipment or system it is connected to.

FCC Caution to the User

The Federal Communications Commission warns the user that changes, or modifications of the unit not expressly approved by the party responsible for compliance could void the user's authority to operate the equipment.

2.3.4 European Union (EU) Requirements

2.3.4.1 RoHS Compliance

Novanta vi Series lasers meet the requirements of the European Parliament and Council Directive 2015/863/EU on the Restriction of the Use of Certain Hazardous Substances in Electrical and Electronic Equipment that establishes maximum concentration values for certain hazardous substances in electrical and electronic equipment.

2.3.4.2 Laser Safety Standards

Under the Low Voltage Directive, 2006/95/EC, the European Norm (EN) document EN 60825- 1:2007 was developed to provide laser safety guidance and includes clauses on Engineering Specifications, Labeling, Other Informational Requirements, Additional Requirements for Specific Laser Products, Classification, and Determination of the Accessible Emission Level. To develop a risk assessment plan/laser safety program for users, see IEC/TR 60825-14:2004 that includes clauses on Administrative Policies, Laser Radiation

Hazards, Determining the MPE, As-associated Hazards, Evaluating Risk, Control Measures, Maintenance of Safe Operation, Incident Reporting and Accident Investigation, and Medical Surveillance.

The vi Series OEM lasers are OEM products intended for incorporation as components in laser processing systems. As supplied by Novanta, these lasers do not meet the requirements of EN 60825-1 without additional safeguards. European Union Directives state that “OEM laser products which are sold to other manufacturers for use as components of any system for subsequent sale are not subject to this Standard, since the final product will itself be subject to the Standard.” This means that Buyers of OEM laser components are solely responsible for the assurance that the laser processing system sold to an end user complies with all laser safety requirements before the actual sale of the system. Note that when an OEM laser component is incorporated into another device or system, the entire machinery installation may be required to conform to EN 60825-1:2004, EN 60204- 1:2016, Safety of Machinery; the Machinery Directive, 2006/42/EC; and/or any other applicable Standards and in cases where the system is being imported into the U.S., it must also comply with CDRH regulations.

In cases where the Buyer is also the end-user of the OEM laser product, the Buyer/end user must integrate the laser so that it complies with all applicable laser safety standards as set forth above. See 2.3.2 *Class 4 Safety Features Required by CDRH & EN60825-1*, for a summary of product features, indicating the type and description of features and whether those features are required by European Union regulations.

2.3.4.3 Electromagnetic Interference Standards

Novanta vi Series lasers have demonstrated performance characteristics that have met or exceeded the requirements of EMC Directive 2014/30/EU.

The European Union’s Electromagnetic Compatibility (EMC) Directive, 2014/30/EU, is the sole Directive developed to address electromagnetic interference (EMI) issues in electronic equipment. In particular, the Directive calls out European Norm (EN) documents that define the emission and immunity standards for specific product categories. For vi Series lasers, EN 61000- 6-4:2018 defines radiated and conducted RF emission limits while EN 61000-6-2:2016 defines immunity standards for industrial environments.

vi Series lasers have demonstrated performance characteristics that have met or exceeded the requirements of EMC Directive 2004(2014)/108/EC.



2.3.4.4 Table: European Union Directives

Applicable Standards/ Norms	
2004(2014)/108(30)/EC	Electromagnetic Compatibility Directive
2006/95/EC	Low Voltage Directive



2015/863/EU	RoHS Directive
EN 61010-1	Safety Requirements for Electrical Equipment for Measurement, Control, and Laboratory Use - Part 1: General Requirements
EN 61000-6-4	Radiated Emissions Group 1, Class A
EN 61000-6-4	Conducted Emissions Group 1, Class A
EN 61000-6-2	Electrostatic Discharge Immunity
EN 61000-6-2	RF Electromagnetic Field Immunity
EN 61000-6-2	Electrical Fast Transient/Burst Immunity
EN 61000-6-2	Conducted RF Disturbances Immunity

After a laser or laser processing system has met the requirements of all applicable EU Directives, the product can bear the official compliance mark of the European Union as a Declaration of Conformity.

2.3.5 vi30 Declaration of Conformity

Declaration of Conformity	
in accordance with ISO / IEC 17050-2:2004	
We,	
Manufacturer's Name:	SYNRAD® A ©Novanta Company
Manufacturer's Address:	4600 Campus Place Mukilteo, WA 98275 U.S.A.
Hereby declare under our sole responsibility that the following equipment:	
Product Name:	Firestar™ OEM vi30 Laser
Model Number:	FSvi30SAC (*OEM)
Conforms to the following Directive(s) and Standard(s):	
Applicable Directive(s):	2014/30/EU Electromagnetic Compatibility Directive 2014/35/EU Low Voltage Directive (EU) 2015/863 RoHS Directive
Applicable Standard(s):	
EN 61010-1:2010	Safety Requirements for Electrical Equipment for Measurement, Control, and Laboratory Use - Part 1: General Requirements
EN 61000-6-4:2007	Radiated Emissions, Group 1, Class A
EN 61000-6-4:2007	Conducted Emissions, Group 1, Class A
EN 61000-6-2:2005	Electrostatic Discharge Immunity
EN 61000-6-2:2005	RF Electronic Fields Immunity
EN 61000-6-2:2005	Electrical Fast Transient/Burst Immunity
EN 61000-6-2:2005	Conducted RF Disturbances Immunity
*OEM lasers do not comply with EN 60825-1:2014, <i>Safety of Laser Products</i> . Buyers of OEM laser products are solely responsible for meeting applicable Directives and Standards for CE compliance and marking.	
Corporate Officer:	European Contact:
	Novanta Distribution (USD) GmbH
Justin Ryser, Quality Manager of SYNRAD	Werk 4
	92442 Wackersdorf, Germany
Date: 12/7/23	
	 MADE IN THE U.S.A. 900-20976-16 Rev D

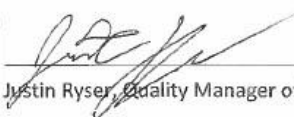
2.3.6 vi40 Declaration of Conformity

Declaration of Conformity	
in accordance with ISO / IEC 17050-2:2004	
We,	
Manufacturer's Name:	SYNRAD® A ©Novanta Company
Manufacturer's Address:	4600 Campus Place Mukilteo, WA 98275 U.S.A.
Hereby declare under our sole responsibility that the following equipment:	
Product Name:	Firestar™ OEM vi40 Laser
Model Number:	FSvi40SAC (*OEM)
Conforms to the following Directive(s) and Standard(s):	
Applicable Directive(s):	2014/30/EU Electromagnetic Compatibility Directive 2014/35/EU Low Voltage Directive (EU) 2015/863 RoHS Directive
Applicable Standard(s):	
EN 61010-1:2010	Safety Requirements for Electrical Equipment for Measurement, Control, and Laboratory Use - Part 1: General Requirements
EN 61000-6-4:2007	Radiated Emissions, Group 1, Class A
EN 61000-6-4:2007	Conducted Emissions, Group 1, Class A
EN 61000-6-2:2005	Electrostatic Discharge Immunity
EN 61000-6-2:2005	RF Electronic Fields Immunity
EN 61000-6-2:2005	Electrical Fast Transient/burst Immunity
EN 61000-6-2:2005	Conducted RF Disturbances Immunity
*OEM lasers do not comply with EN 60825-1:2014, <i>Safety of Laser Products</i> . Buyers of OEM laser products are solely responsible for meeting applicable Directives and Standards for CE compliance and marking.	
Corporate Officer:	European Contact:
	Novanta Distribution (USD) GmbH
Justin Ryser, Quality Manager of SYNRAD	Werk 4
	92442 Wackersdorf, Germany
Date: 12/7/23	
	 MADE IN THE U.S.A. 900-20976-10 Rev D

3 Getting Started

Use information in this chapter to prepare your OEM vi30 for operations. The order of information presented in this chapter is the same as the order of tasks that you will need to perform. The best way to get your laser ready for operation is to start at *Unpacking* and work your way through *Connecting*.

3.1 Introduction

The vi Series lasers are more compact versions of the successful v Series lasers and were designed to provide OEMs with the smallest possible 30W laser package. The optoisolated PWM input, PWM Positive, on the DB-9 I/O connector is identical to that on the v30 laser, and like the v30, the vi30 does *not* incorporate a built-in tickle generator. Users must provide a 5 kHz, 1 μ s tickle pulse between applied PWM signals. All input/output signals on the vi30s DB-9 I/O connector are identical to the v30 I/O signals and operate at the same 5V logic levels to ensure compatibility and ease of installation when retrofitting the vi30 into existing v30 laser systems.

In addition to the standard vi30 mounting method (see the Mounting section later in this chapter), there are two optional vi30 mounting kits available separately from the factory. The feet in the "Tall" mounting kit raise the vi30 by 5.9 mm to match the v30 beam exit height without extending beyond the width of the vi30 baseplate. The "Tall/wide" kit raises the vi30 to match the v30 beam exit height while the wider feet allow the vi30 to fit into the existing v30 mounting location.

The vi30 laser is available in an air-cooled, fan-cooled, and water-cooled configuration. The vi40 laser is available in an air-cooled configuration. Air-cooled configurations require that the OEM or end user supply the appropriate means of cooling the laser.

The vi Series lasers are OEM products intended for incorporation as a component in a laser processing system, and as such do not comply with 21 CFR, Subchapter J, or EN60825-1, without additional safeguards.

3.1.1 Nomenclature

The laser part number structure is shown in 3.1.2 *Figure: Decoding Part Numbers*. The part number includes information specifying:

- Average power or peak power optimization: "FS" indicates the laser is optimized for average power and CW operation, "PS" indicates it is optimized for high peak power and pulsed operation.
- Product family: "vi" indicates it is part of the vi Series product family. Other options include "ti", "f", "i", and "p".
- Average power: "30" for 30W, "40" for 40W, etc.

- Safety configuration: “K” for Keyswitch or “S” Standard OEM models. The vi Series lasers are only available in the Standard OEM configuration.
- Cooling option: “W” for water-cooled units, “F” for fan-cooled units, and “A” for air-cooled lasers (where the OEM or end user must provide cooling via fans or blowers)
- Revision letter: indicates the current model revision
- Manufacturing location: “S” for Suzhou, or no letter for Mukilteo
- Wavelength: No number or “10.6” for 10.6 μm wavelength, “10.2” for 10.2 μm , etc.

For example, the model number FSVI30SAD-10.6 designates a CW laser, part of the vi Series family, 30W average power, standard OEM, air-cooled, revision D, manufactured in Mukilteo, and 10.6 μm wavelength.

3.1.2 Figure: Decoding Part Numbers

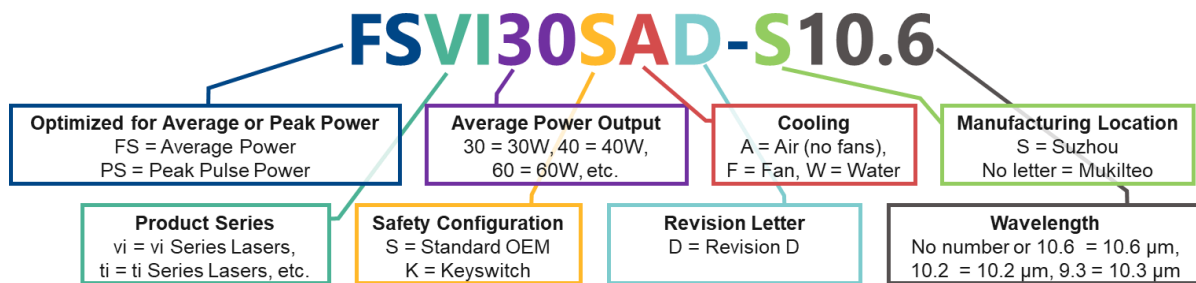

3.2 Unpacking

3.2.1 Incoming Inspection

Upon arrival, inspect all shipping containers for signs of damage. If you discover shipping damage, document the damage (photographically if possible), then immediately notify the shipping carrier and Novanta.

The shipping carrier is responsible for any damage occurring during transportation from Novanta to your receiving dock.

3.2.2 Packaging Guidelines

- To prevent equipment damage or loss of smaller components, use care when removing packaging materials

- After unpacking, review 3.2.3 Inventory and verify that all components are on hand
- Save all shipping containers and packaging materials, including covers and plugs. Its unique design prevents damage to your laser during storage, relocation and/or shipping.

Caution: Possible Equipment Damage

Lift the laser only by the mounting feet or baseplate. Do not lift or support the laser by anything else, e.g. its cooling fittings.

3.2.2.1 Repackaging or Storing

When shipping Novanta lasers to another facility, we highly recommend that you ship the unit in its original Novanta shipping container. If you no longer have the original shipping box and inserts, contact Novanta Customer Service about purchasing replacement packaging.

When packing a laser for shipment, be sure to remove all accessory items not originally attached to the laser, including beam delivery components, connectors, etc.

Refer to section 4.5.4 Packaging Instructions drawing in the Technical Reference chapter for details on packaging the laser using Novanta-supplied shipping materials.

Caution: Possible Equipment Damage

When preparing the laser for storage or shipping, remember to drain cooling water from the laser. In cold climates, any water left in the cooling system may freeze, which could damage internal components. After draining thoroughly, use compressed shop air at less than 29 PSI (wear safety glasses!) to remove any residual water. When finished, cap all connectors to prevent debris from entering the cooling system.

Important Note:

Failure to properly package the laser using Novanta-supplied shipping boxes and foam/cardboard inserts as shown in the Packaging instructions (section 4.5.4) may void the warranty. Customers may incur additional repair charges for shipping damage caused by improper packaging.

3.2.3 Table: vi Series Shipment Inventory

Contents	Qty	Additional Information
vi Series Laser	1	For cutting, welding, drilling, and marking a wide variety of products and materials
Customer Communication Flier		Follow the instructions on the flier to access the latest manual on the Novanta website
Cooling kit	1	Only with fan and water-cooled models
DC power cable set	1	
Mounting Bolts	3	Three each 1/4-20 x 5/8 UNC caps crews are provided for fastening the vi Series laser to your mounting surface.
Spare Fuse	4	A fast-blow fuse incorporated into the positive DC power cable protects the laser's internal circuitry. Two fast-blow 12 A Cooper Bussmann BK/ABC-12-R or RoHS equivalent fuses (for vi30). Two fast-blow 20 A Cooper Bussmann ABC-20-R or equivalent fuses (for vi40). See Troubleshooting in the Maintenance and Troubleshooting chapter for additional information.
Final Test Report	1	Contains data collected during the laser's final pre-shipment test.

3.3 Mounting

The vi Series baseplates (and optional mounting feet) are designed so the laser is easily mounted to either vertical or horizontal surfaces using only three fasteners. Three ball bearing "feet" pressed into the baseplate (and the optional mounting feet) eliminate any possible distortion of the laser tube caused by variations in the flatness of the mounting surface.

Refer to the outline and mounting drawings in the Technical Reference chapter for mounting locations and dimensions.

Important Note

To prevent possible distortion of the tube, you must fasten the vi Series laser directly to your mounting surface using the base plate or the optional mounting feet.

Caution: Possible Equipment Damage

Novanta does not recommend mounting lasers in a vertical “head-down” or equipment “tail-down” orientation. If you must mount your laser in this manner, please contact the factory for limitations as a vertical orientation increases the risk of damage to the laser’s output optic.

Failure to properly package the laser using Novanta shipping box and foam/cardboard inserts as shown in Packaging Instructions (section 4.5.4) may void the warranty. Customers may incur additional repair charges due to shipping damage caused by improper packaging.

3.3.1 Mounting the vi Series Laser

To fasten the vi Series laser to your mounting surface using a base or ‘mounting plate’, perform the following steps:

1. Refer to the appropriate vi Series outline and mounting drawing, and drill three holes into your mounting surface that correspond to either the ISO (metric) or UNC fastener pattern shown in the drawing.
2. Place the laser on the mounting surface so the threaded holes in the baseplate line up with the holes in your mounting surface as shown in 3.3.1.1 Figure: vi30 Mounting Locations.

Note

Mounting bolts must not extend further than 6.0 mm (0.24”) into the vi Series baseplate.

When mounting the laser, use only one metric or SAE fastener per mounting tap on the baseplate.

Do not use any type of jackscrew arrangement as this will twist the baseplate and may distort the tube.

3. Insert three M6 × 1 ISO or 1/4–20 UNC fasteners through the mounting surface into the corresponding threaded holes in the baseplate. Turn the screws by hand until the threads engage.
4. Evenly tighten all three fasteners to a maximum torque of 6.1 N m (54 in lb).

3.3.1.1 Figure: vi30 Mounting Locations

1/4-20 fastener locations shown.

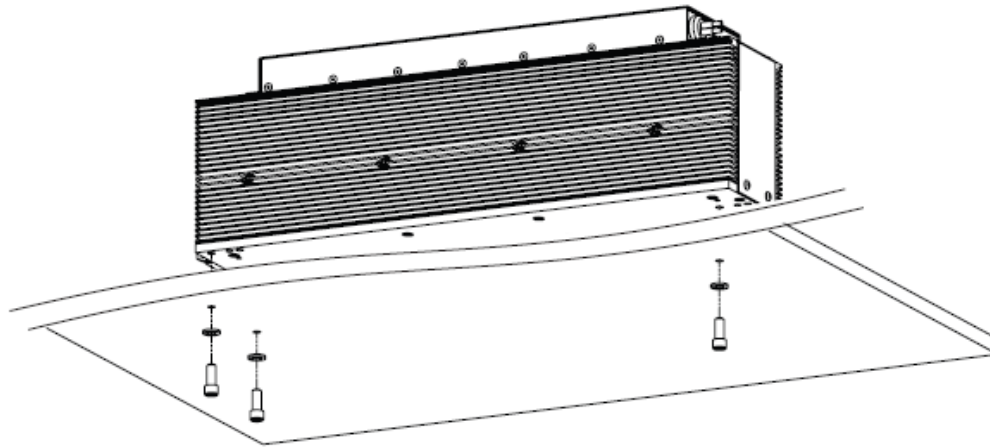

3.3.2 Optional Mounting Feet

For most customers, the standard baseplate design provides the smallest physical footprint for mounting the laser in a compact laser system. Where mounting compatibility to the v Series lasers is required, you can purchase and install one of two optional mounting kits (available separately from the factory). The 'Tall' mounting kit (P/N 250-20190-01) raises the laser by 5.9 mm (0.231") to match the v30 beam exit height. Feet in the 'Tall/ Wide' mounting kit (P/N 250-20190-02) raise the laser to match v30 beam exit height and mounting dimensions exactly. All three mounting options are shown in 3.3.2.1 *Figure: Tall and Tall/Wide Mounting Feet*.

3.3.2.1 Figure: Tall and Tall/Wide Mounting Feet

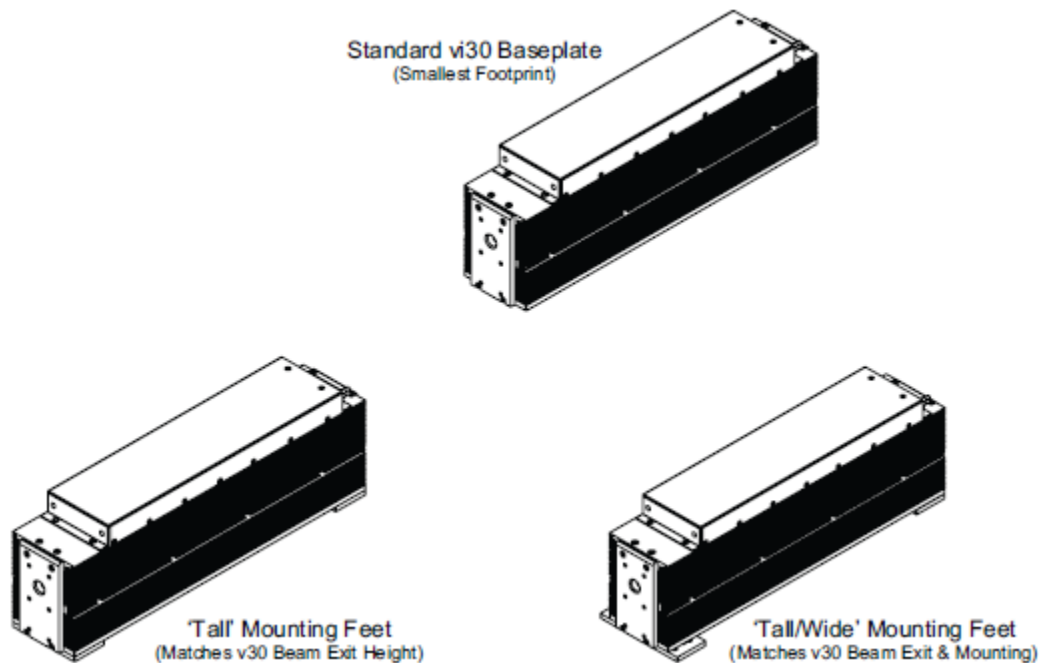

3.3.2.2 Install the optional mounting feet

Contact our technical support team for more information on attaching the "Tall" or "Tall/Wide" mounting feet. Please refer to 1.6 *Technical Support* for contact information.

3.4 Cooling

There are three cooling configurations available:

1. **Air:** Also referred to as the OEM cooling configuration. Customers must provide forced air cooling to prevent the laser from overheating.
2. **Fan:** Includes a fan shroud that fits over the laser. Shroud includes fans that are positioned on both sides of the laser.
If your laser is fan-cooled (i.e. FSvi30SFD...) you may skip ahead to section **below 3.5 Connecting**.
3. **Water:** Chassis design includes tubing for water circulation. Customers must provide a chiller to cool and circulate the water.
If your laser is water-cooled (i.e. FSvi30SWD...) you may skip ahead to section **3.4.2 Water Cooling**.

3.4.1 Air Cooling

The air-cooled versions of the vi Series lasers do not include cooling fans. Customers must provide some type of air cooling to prevent the laser from overheating.

The air/OEM vi Series does not provide a voltage output sufficient to power cooling fans, so customers must provide an external power source to drive the selected cooling fans. Because of the heat generated by internal RF circuitry, establishing significant airflow evenly over the entire surface of the combined laser/RF chassis is vitally important to the performance and longevity of the laser.

3.4.1.1 Side Cooling

Novanta recommends using two cooling fans rated at least 4.0 m³/min (140 CFM) for the vi30, and 5.4m³/min (190 CFM) for the vi40. This assumes a static air pressure of 13.9 mm H₂O (0.52 in H₂O). The cooling fans should measure 120 × 120 mm (4.7" × 4.7") and have at least 57.2 mm (2.25") of unobstructed clearance between the rear face of the fan housing and any mounting surface or enclosure.

For free-space mounting (no fan shroud), position the fans symmetrically, as shown in 3.4.1.2 *Figure: Cooling Fan Locations*, where they are centered horizontally with the laser chassis and vertically with the heat-sink fins. Position both fans so the front face is no more than 76mm (3.0") from the vi Series' heat-sink fins.

When using a tight-fitting fan shroud designed for side cooling, the cooling fans can be positioned within 5–25 mm (0.20–1.0") of the heat-sink fins, as long as the same gap is maintained on either side.

Important Note:

Fans should be centered both horizontally and vertically on each side of the laser.

Gap between fan and laser must be less than 3.0 in (76 mm) for sufficient air flow through the cooling fins.

Gap between fan and wall (or other housing structure) must be at least 2.25 in (57 mm).

3.4.1.2 Figure: Cooling Fan Locations (Side)

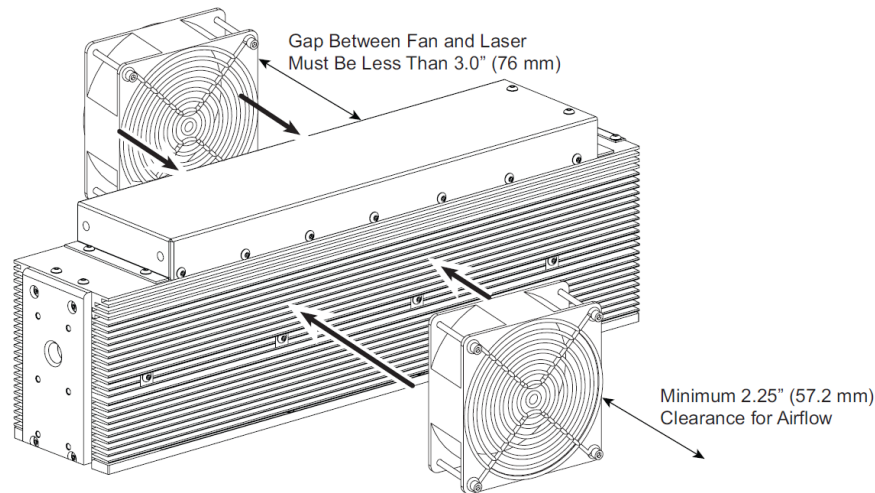

3.4.1.3 Rear Cooling

For the vi30 Series lasers, a fan shroud designed for rear cooling can be used to minimize the width of the laser installation, as shown in 3.4.1.4 *Figure: Alternate vi30 Cooling Fan (Rear)*.

Guidelines for rear cooling:

- The shroud should enclose the full length of the laser and the cooling fan
- Fit the shroud snugly against the laser's heat-sink fins, so air is ducted between the fins (not around them)
- For proper heat removal, open the shroud at the front to direct air flow through the laser
- Use a fan rated for at least 8.5 m³/min (300 CFM) at a static air pressure of 23.9 mm H₂O (0.94 in H₂O) and position it approximately 150 mm (6.0") from the rear of the laser

Caution: Possible Equipment Damage

Shroud must enclose both the laser and rear cooling fan. Fit the shroud snugly against the laser's heat-sink fins, so air is ducted between the fins (not around them).

3.4.1.4 Figure: Alternate vi30 Cooling Fan (Rear)

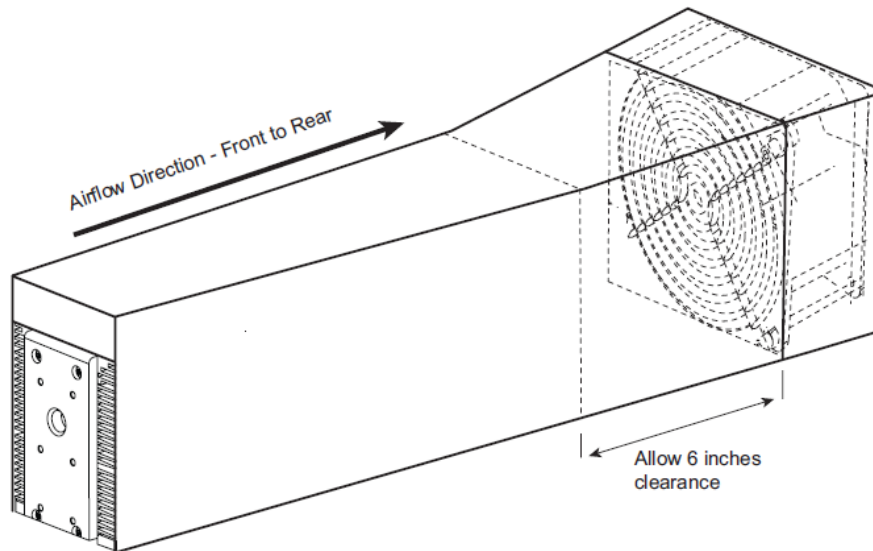

3.4.2 Water Cooling

For the water-cooled version, customers are required to provide a chiller to cool and circulate the water. This section explains how to connect the laser and chiller and includes guidelines for operating.

3.4.2.1 Cooling Fitting Adaptors

If your integrated laser application uses metric cooling tubing, you should install tubing adaptors to convert the lasers WATER IN and WATER OUT fittings from 1/2-inch tubing to 12mm metric tubing. These tubing adaptors are available from many tubing and fitting manufacturers.

3.4.2.2 Cutting and Installing Tubing

- Cut tubing lengths generously to allow for trimming
- Cut tubing squarely; diagonal cuts may not seal properly. Carefully trim any burrs if the cut is ragged
- Avoid excessive stress of fittings; create gentle bends when routing tubing close to connectors. Excessive stress from sharp bends will compromise the sealing properties of the fitting.
- Never allow the tubing to kink, since kinking severely restricts coolant flow.
- Push tubing completely into the fitting, then pull the tubing to verify that it is locked into place.

- If tubing must be disconnected from a fitting, first push and hold the tubing slightly into the fitting. Next push the release collet evenly towards the fitting, and then pull the tubing free.
- After disconnecting the tubing from a fitting, trim about 12.7 mm (0.5") from its end before reconnecting. Trimming the end of the tubing before reconnecting the fitting provides an undisturbed sealing surface.

3.4.2.3 Chiller Preparation

- You must provide fittings to adapt the laser's ½-inch O.D. polyethylene cooling tubing to your chiller's Inlet and Outlet ports. These fittings can be "quick disconnect" or compression type fittings.
- Because the vi Series cooling tubing is specified in inch sizes, do not use metric tubing fittings unless you have installed the appropriate inch-to-metric tubing adaptors. The use of metric fittings on inch size tubing will lead to coolant leaks or may allow the pressurized tubing to blow off the fitting.

3.4.2.4 Coolants

Novanta recommends that the laser's cooling fluid contains at least 90% distilled or tap water by volume. In closed-loop systems, use a corrosion inhibitor/algaecide such as Optishield Plus or equivalent as required.

Avoid glycol-based additives because they reduce the coolant's heat capacity and high concentrations may affect power stability. If you must use glycol, do not add more than 10% by volume. The minimum coolant setpoint is 18°C (64°F) so glycol is not necessary unless the chiller is subjected to freezing temperatures.

If tap water is used, chloride levels should not exceed a concentration of 25 parts per million (PPM). Install a filter on the chiller's return line and inspect frequently. The following wetted materials are in the cooling path in the laser: nickel-plated brass, copper, acetal, PBT, polyethylene, stainless steel, and Viton.

Ensure that coolant flow is 1.0 GPM (3.8 LPM), and the pressure does not exceed 60 PSI (4.1 bar, 414 kPa).

Caution: Possible Equipment Damage

Do **not** use de-ionized (DI) water as a coolant. DI water is unusually corrosive and is not recommended for mixed material cooling systems.

3.4.2.5 Setting Coolant Temperature

Choosing the correct coolant temperature is important to the proper operation and longevity of your laser. When coolant temperature is lower than the dew point (the temperature at which moisture condenses out of the surrounding air), condensation forms inside the laser housing leading to failure of laser electronics as well as damage to optical surfaces.

The greatest risk of condensation damage occurs when the laser is in a high heat/high humidity environment and the chiller's coolant temperature is colder than the dew point of the surrounding air or when the system is shut down, but coolant continues to flow through the laser for extended periods of time.

The chiller's temperature set-point must always be set **above** the dew point temperature. In cases where this is not possible within the specified coolant temperature range of 18 °C to 22 °C (64 °F to 72 °F), then the following steps **MUST** be taken to reduce the risk of condensation damage.

- Air-condition the room or the enclosure containing the laser.
- Install a dehumidifier to reduce the humidity of the enclosure containing the laser.
- Stop coolant flow when the laser is shut down.
- Increase coolant flow by an additional 1.0 GPM (3.8 lpm). Do not exceed a coolant pressure of 60 PSI (414 kPa).

See 3.4.2.6 *Table: Dew Point Temperatures* for a range of air temperatures and relative humidity values. Remember that the laser's coolant temperature must be set above the dew point temperature shown in the table. For best results and performance, however, do not exceed a coolant temperature of 22 °C (72 °F).

Caution: Possible Equipment Damage

The laser's coolant temperature must be set above the dew point temperatures but should not exceed 22 °C (72 °F).

Note

The vi Series lasers can be operated at coolant temperatures up to 30 °C to reduce problems associated with condensation; however, this may result in decreased laser performance and/or reduced laser lifetime.

3.4.2.6 Table: Dew Point Temperatures

The laser's coolant temperature must be set above the dew point temperatures shown in the chart but should not exceed 22 °C (72 °F).

Air Temp °F/°C	Relative Humidity															
	20%	25%	30%	35%	40%	45%	50%	55%	60%	65%	70%	75%	80%	85%	90%	95%
60 °F	-	-	-	32	36	39	41	44	46	48	50	52	54	55	57	59
16 °C	-	-	-	0	2	4	5	7	8	9	10	11	12	13	14	15
65 °F	-	-	33	37	40	43	46	48	51	53	55	57	59	60	62	64
18 °C	-	-	1	3	4	6	8	9	11	12	13	14	15	16	17	18
70 °F	-	33	37	41	45	48	51	53	56	58	60	62	64	65	67	69
21 °C	-	1	3	5	7	9	11	12	13	14	16	17	18	18	19	21
75 °F	-	37	42	46	49	52	55	58	60	62	65	67	68	70	72	73
24 °C	-	3	6	8	9	11	13	14	16	17	18	19	20	21	22	23
80 °F	35	41	46	50	54	57	60	62	65	67	69	71	73	75	77	78
27 °C	2	5	8	10	12	14	16	17	18	19	21	22	23	24	25	26
85 °F	40	45	50	54	58	61	64	67	70	72	74	76	78	80	82	83
29 °C	4	7	10	12	14	16	18	19	21	22	23	24	26	27	28	28
90 °F	44	50	54	59	62	66	69	72	74	77	79	81	83	85	87	88
32 °C	7	10	12	15	17	19	21	22	23	25	26	27	28	29	31	31
95 °F	48	54	59	63	67	70	73	76	79	81	84	86	88	90	92	93
35 °C	9	12	15	17	19	21	23	24	26	27	29	30	31	32	33	34
100 °F	52	58	63	68	71	75	78	81	84	86	88	91	93	95	97	98
38 °C	11	14	17	20	22	24	26	27	29	30	31	33	34	35	36	37

To use this table, look down the Air Temp column and locate an air temperature that corresponds to the air temperature in the area where your laser is operating. Follow this row across until you reach a column that matches the relative humidity in your location. The value at the intersection of the Air Temp and

Relative Humidity columns is the Dew Point Temperature. The chiller's temperature setpoint must be **above** the dew point temperature.

For example, if the air temperature is 85°F (29°C) and the relative humidity is 60%, then the dew point temperature is 70°F (21°C). Adjust the chiller's temperature setpoint to 72°F (22°C) to prevent condensation from forming inside the laser.

3.4.2.7 Cooling Tubing Connections

The following procedure will guide you in configuring the most efficient cooling system. Please connect your system exactly as described below.

To connect cooling tubing to your laser, perform the following steps:

1. Cut and connect a length of ½-inch O.D. polyethylene cooling tubing to fit between the chiller's Outlet port and the upper WATER IN power on the rear of the laser
2. Cut and connect a length of tubing to fit between the lower WATER OUT port on the rear of the laser and the chiller's Inlet port.
3. Turn on the chiller and adjust the coolant temperature setpoint to be between 18 and 22°C. Regulate coolant flow to 1.0 GPM (3.8 lpm) and less than 60 PSI (414 kPa) of pressure.
4. Closely examine all cooling connections and verify that there are no leaks.

Caution: Possible Equipment Damage

Inlet coolant temperature must be maintained above the dew point temperature to prevent condensation and water damage to the laser.

Do not exceed coolant pressure of 60 PSI (414 kPa).

3.4.3 Temperature Monitoring

For customers who wish to monitor vi30 chassis temperature, see 3.4.3.1 *Figure: vi30 External Temperature Monitoring Location* for the recommended location of an external temperature sensor. Temperature sensors are not included and must be supplied by the customer. A reading of approximately 70 °C (158 °F) will trigger over-temperature faults.

The vi40 has built-in temperature monitoring, and a reading of 70 °C (158 °F) will trigger over-temperature faults. See section 4.3.4 in the Technical Reference chapter for more information on vi40 temperature monitoring.

3.4.3.1 Figure: vi30 External Temperature Monitoring Location



3.5 Electrical Connections

The following procedures describe how to complete electrical connections to the vi Series lasers. The vi30 DC power cables are manufactured from #12 AWG wire and measure 1 meter (40 inches) in length.

3.5.1 DC Power Supply

The vi30 laser requires a DC power supply capable of providing 48 VDC at 10 A minimum (11 A peak for less than 1 ms). The vi40 laser requires 48 VDC at 15 A minimum (17 A peak for less than 1 ms).

To connect your vi Series laser to a 48 VDC power supply, perform the following steps:

1. Verify that input AC power to the DC power supply is physically locked out or disconnected.
2. Locate the 48 VDC output terminals on the power supply's output section and connect the black (-) DC power cable from the laser to the negative (V-) output terminal.
3. Connect the red (+) DC power cable from the laser to the positive (V+) 48 VDC output terminal

Caution: Possible Equipment Damage

Do not reverse polarity when connecting DC power cables to your DC power source. Reversed DC polarity may damage the vi Series laser's internal RF and control board circuitry. Carefully follow the directions to ensure that DC cable leads are properly connected to the correct DC output terminals.

Note:

The negative (-) side of the DC input to the laser is internally connected so that the laser chassis serves as DC power ground. You should isolate the laser's DC power supply so that the only grounded connection is at the laser. Alternatively, you can mount the laser chassis on an insulating pad or film in order to electrically isolate the laser when other equipment is grounded to the laser's DC power supply.

3.5.2 Control Connections

Control connections to the vi Series lasers are made through the DB-9 I/O connector on the laser's rear panel. The DB-9 interface connector receives tickle pulse and PWM Command signals and also serves as the connection point for auxiliary signal between the laser and any parts handling, automation, or monitoring equipment. See the DB-9 I/O connections section in the Technical Reference chapter for details.

Because the vi Series control board does not incorporate a built-in tickle generator, an externally generated 5 kHz, 1 μ s tickle pulse between applied PWM signals is required to achieve optimum laser performance. See Controlling laser power in the Technical Reference chapter for tickle signal descriptions.

**Warning: Serious Personal Injury**

Always use shielded cable when connecting your PWM Command signal source to PWM Positive/PWM Negative inputs.

In electrically noisy environments, long lengths of unshielded wire act like an antenna and may generate enough voltage to trigger uncommanded lasing.

3.5.2.1 UC-2000 Universal Laser Controller

For testing, troubleshooting, and basic operation, we recommend using a UC-2000 Controller to generate tickle pulses and Pulse Width Modulation (PWM) command signals necessary to control laser output power. To connect a UC-2000 Controller, perform the following steps:

1. Remove DC power from the laser.
2. Fabricate a suitable DB-9 plug so Pin 1, PWM Positive, connects to the center pin of the Power/Control cable's BNC connector and Pin 6, PWM Negative, connects to the shield.

3. If your system does not provide an enable input to the DB-9 plug, then jumper Pin 9, Laser Enable, to Pin 5, DC Out.

**Danger: Serious Personal Injury**

Jumpering Pin 9, Laser Enable, to Pin 5, DC Out, bypasses the laser enable function, potentially exposing personnel to hazardous invisible laser radiation. See Laser Enable pin description in 4.3.1.2 Table: DB-9 I/O Pin Descriptions.

4. Connect the DB-9 plug to the DB-9 I/O connector on the rear of the laser.
5. Connect the mini-DIN connector of the UC-2000's Power/Control cable to the Laser connector on the UC-2000's rear panel.
6. Attach the BNC connector from the Power/Control cable to the BNC connector on DB-9 plug, attached to the User I/O port
7. Connect the miniature DC power plug on the UC-2000's Power/Control cable to the miniature connector on the wall plug transformer cable.
8. Plug the compact transformer into any 100–240 VAC, 50–60 Hz outlet.

Caution: Possible Equipment Damage

Turn off DC power before installing or removing any plug or cable from the DB-9 I/O connector. Ensure that user connections are made to the appropriate pins and that the appropriate signal levels are applied. Failure to do so may damage the laser.

Note:

The UC-2000 Universal Laser Controller, also available from Novanta, is sold separately.

Note:

The vi Series laser can also be controlled from an alternate user-supplied Command signal source. Refer to Controlling laser power in the Technical Reference chapter for control signal descriptions. Refer to DB-9 I/O connection, also in the Technical Reference chapter, for signal specifications and connection details.

3.6 Controls and Indicators

Use information in this chapter to familiarize yourself with the vi Series controls and indicators on the front and rear panels of the laser.

3.6.1 Front Panel

The front panel contains the following features, also shown in 3.6.2 *Figure: Front Panel*:

- Aperture Seal – prevents dust from damaging laser optics during shipping. Remove the self-adhesive label before applying power to the laser.
- Laser Aperture – provides an opening in the vi Series' front panel from which the beam exits.
- Optical Accessories Mounting – provides six threaded holes (8–32 UNC) for mounting optional beam delivery components. Because excessive weight may damage the laser, consult Novanta before mounting components not specifically designed as options. Refer to the vi Series outline and mounting drawings in the Technical Reference section for mounting dimensions

3.6.2 Figure: Front Panel

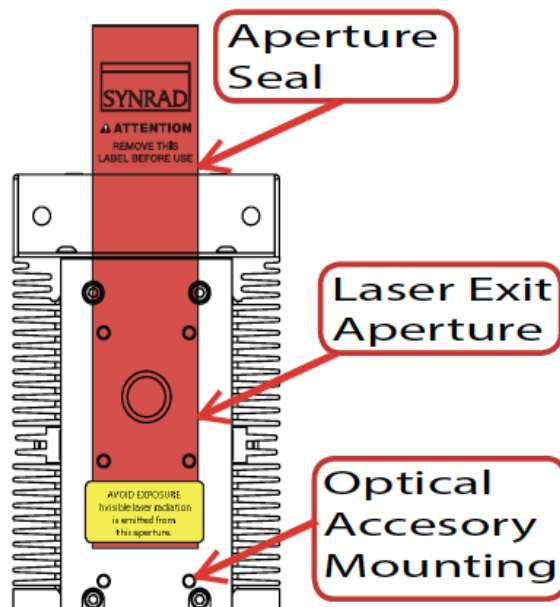

Important Note:

Remove the self-adhesive seal before applying power to the laser.

Important Note:

To prevent damage when mounting optical components to the vi Series lasers, the 8–32 UNC fasteners must extend no further than 4.8 mm (0.19") into the laser's faceplate.

3.6.3 Rear Panel

The rear panel contains the following features, also shown in 3.6.4 *Figure: Rear Panel*:

- DC Power Cables – receives +48 VDC from the DC power supply. The DC power cables are manufactured from #12 AWG wire and measure 1 meter (42 inches) in length. The red (positive) cable contains a replaceable in-line fuse. If vi Series fuse replacement is required, refer to the vi Series Shipment inventory (section 3.2.3) for more information.
- DB-9 I/O Connector – provides a connection point for auxiliary output power as well as input and output signals. Refer to DB-9 I/O connections in the Technical Reference chapter for pinouts and signal descriptions.
- LASE Indicator – illuminates red to indicate that the laser is actively lasing. The LASE indicator is off when tickle pulses are being generated and illuminates red when PWM Command signal pulses are long enough to produce laser output.
- RDY (Ready) Indicator – illuminates yellow when the laser is enabled, indicating that, after an initial five-second delay, lasing will begin when a PWM Command signal is applied.
- PWR (Power) Indicator – illuminates green when +48 VDC power is applied to the laser.

3.6.4 Figure: Rear Panel

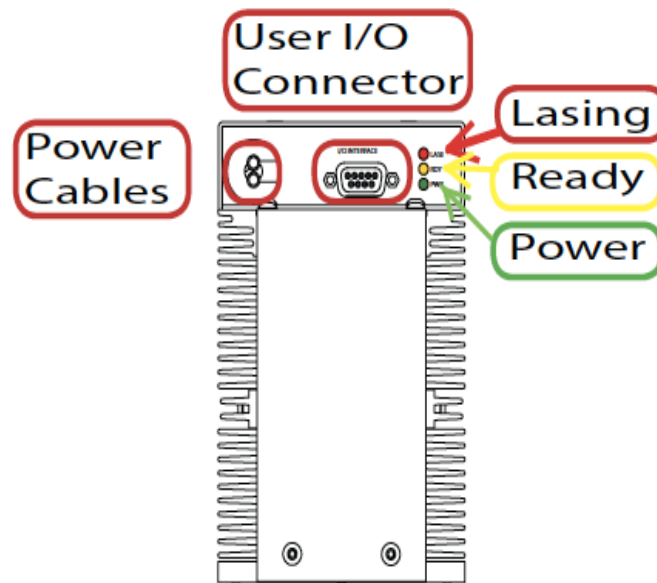

3.7 Initial Start-Up

This section explains the status indicators and how to start the laser with and without a UC-2000 controller.

3.7.1 Status Indicators

Three status indicators (LEDs) on the rear of the laser provide a visual indication of operating status. A green PWR indicator illuminates when DC power is applied to the laser. The yellow RDY indicator means that a Laser Enable signal has been applied and that, after a five-second delay, lasing will begin once a PWM Command signal is received. The LASE indicator illuminates red to show that the PWM signal is sufficient to induce laser output.

**Danger: Serious Personal Injury**

Any Class 4 CO₂ laser product that emits invisible infrared laser radiation in the 9–11 μm wavelength band can seriously burn human tissue.

Because direct or diffuse laser radiation can inflict severe corneal injuries, always wear eye protection when in the same area as an exposed laser beam.

Do not allow the laser beam to contact a person.

Always be aware of the beam's path and always use a beam block while testing.

Caution: Possible Equipment Damage

Remove the aperture seal before firing the laser. The self-adhesive seal is installed to prevent dust from entering the laser housing during shipment and installation and must be removed before operation.

3.7.2 With a UC-2000 Controller

Before your laser is used, its functionality should be verified. Follow this procedure to verify the laser system is operating at optimum performance. For this procedure, use the UC-2000 as a stand-alone controller; do not attempt to control the laser or UC-2000 externally.

Note:

After applying 48 VDC, but before operating the laser, you must provide a Laser Enable input signal to the DB-9 I/O connector. See DB-9 I/O connections in the Technical Reference chapter for pinouts and signal descriptions.

Start Auxiliary Equipment

1. Ensure that all personnel in the area wear protective eyewear
2. Remove the self-adhesive aperture seal from the laser faceplate
3. Place a power meter, or appropriate beam block, about 2 feet (61 cm) from the laser aperture to prevent the beam from traveling beyond the work area.
4. Set the UC-2000 to MANUAL mode, and then set the PWM Adj Knob to provide zero percent output (0.0%). The UC-2000's Lase indicator should be Off.

Note:

If you have not yet operated your UC-2000 Universal Laser Controller, refer to the UC-2000 Laser Controller Operator's Manual for setup and operation instructions before continuing.

Start vi Series Laser

1. If the laser has a Diode Pointer installed, remove its aperture dust cover.
2. Turn on the +48 VDC power supply. The PWR indicator on the laser should illuminate green
3. Apply a Laser Enable signal to the DB-9 I/O connector. The yellow RDY indicator turns on to show that, after a five-second delay, lasing is enabled when a PWM Command signal is received.

Note:

On cold starts, provide five to ten seconds of tickle before sending PWM Commands to the laser.

4. Press the UC-2000's Lase On/Off button. The Lase indicator on the UC-2000 should illuminate.
5. Use the UC-2000's PWM Adj knob to slowly increase power. The laser's LASE indicator illuminates red when PWM Command pulses are long enough to produce laser output. The spot where the beam hits the beam block should increase in brightness to indicate increased power output.
6. Press the UC-2000's Lase On/Off button to stop lasing. LASE indicators on the UC-2000 and the laser should turn off.

If your laser fails to lase, refer to Troubleshooting in Maintenance/Troubleshooting chapter for troubleshooting information.

3.7.3 Without a UC-2000 Controller

If you are not using a UC-2000 to control the laser, follow the steps below to verify laser operation. For all vi Series lasers, an externally-generated tickle signal is required for optimum laser performance. Connect the signal generator for both tickle and PWM Command signals to the DB-9 I/O connector. Refer to DB-9 I/O connections in the Technical Reference chapter for tickle and Command signal descriptions.

Note:

After applying 48 VDC, but before operating the laser, you must provide a Laser Enable input signal to the DB-9 I/O connector. See DB-9 I/O connections in the Technical Reference chapter for pinouts and signal descriptions.

Start Auxiliary Equipment

1. Ensure that all personnel in the area wear protective eyewear
2. Remove the self-adhesive aperture seal from the laser faceplate
3. Place a power meter, or appropriate beam block, about 2 feet (61 cm) from the laser aperture to prevent the beam from traveling beyond the work area.
4. Connect the output of your PWM controller to PWM Positive (Pin 1) on the laser's DB-9 I/O connector and connect the ground or return of the Controller to the PWM Negative (Pin 6).

Note:

Your controller must provide both tickle and PWM Command signals to the laser. See Controlling laser power in the Technical Reference chapter for tickle and Command signal descriptions.

5. Ensure your controller is set to provide a 1 μ s square wave tickle pulse at a frequency of 5 kHz during any 200- μ s measurement period where a PWM signal is not applied.
6. Set your PWM controller to a frequency of 5 kHz (at a +5 volt level) and ensure that the controller's duty cycle is set to zero percent output (0.0%).

Start vi Series Laser

1. If the laser has a Diode Pointer installed, remove its aperture dust cover.
2. Turn on the +48 VDC power supply. The PWR indicator on the laser should illuminate green
3. Apply a Laser Enable signal to the DB-9 I/O connector. The yellow RDY indicator turns on to show that, after a five-second delay, lasing is enabled when a PWM Command signal is received.

Note:

On cold starts, provide five to ten seconds of tickle before sending PWM Commands to the laser.

4. Using your PWM controller, apply tickle pulses (a +5 VDC, 5 kHz square wave of 1 μ s duration). After 5 to 10 seconds slowly increase the duty cycle of the square wave. The LASE indicator illuminates red

when PWM pulses are long enough to produce laser output. The spot where the beam hits the beam block should increase in brightness to indicate increased power output.

5. Remove the PWM Command signal from the laser and reapply tickle pulses every 200 μ s. The LASE indicator on the laser should turn off.

If your laser fails to lase, refer to Troubleshooting in Maintenance/Troubleshooting chapter for troubleshooting information.

4 Technical Reference

Use Information in this chapter as a technical reference for your vi Series laser.

4.1 Technical Overview

4.1.1 vi Series Laser Design

4.1.1.1 Laser Tube

The vi Series lasers were developed using modern technology patented by Novanta, Inc. This patented “v” technology, based on a combination of free-space and waveguide resonator designs, enables Novanta to economically produce a symmetrical laser beam from a small but powerful laser capable of operating for many years with no maintenance. Its unique extruded aluminum envelope offers excellent heat transfer, long gas life, and low operating costs in contrast to other laser tube technologies. In addition to maintaining the lasing environment, the aluminum tube is also the structural platform that integrates the laser’s optical, electrical, and cooling components.

Caution: Possible Equipment Damage

Because of their smaller beam diameter, vi30 lasers have significantly higher power densities than previous Novanta lasers. This means that even a small amount of contamination on the laser’s output window (or on any optic in the beam path) can absorb enough energy to damage the optic. Inspect the output window and other beam delivery optics periodically for signs of contaminants and carefully clean as required. In dirty environments, purge laser optics using filtered air or nitrogen to prevent vapor and debris from accumulating on optical surfaces.

4.1.1.2 Optical Resonator

The optical resonator, in conjunction with the electrodes and the gas mixture, generates the laser beam. vi Series optical resonators are comprised of four optical elements: a rear mirror, two turning mirrors, and an

output window. These optical elements are fastened to the tube's exterior and are exposed to its interior through holes in the end caps. O-rings sandwiched between optical elements and each end cap form a gas seal and provide a flexible cushion that allows the slight movement necessary for alignment. All optical elements are aligned and locked into place by factory technicians before the laser is shipped.

The output beam, roughly circular as it exits the resonator, transitions to a Gaussian-like mode in mid and far fields—three meters (9.8 ft) and beyond. The internal structure and optics of the resonator combine to produce a Gaussian-like mode quality (M^2 factor) of < 1.2 . As shown in the following figure, beam waist diameter is $2.5 \text{ mm} \pm 0.5 \text{ mm}$ at the output aperture and full angle divergence due to diffraction is less than 7 milliradians (a 7 mrad full angle divergence means that beam diameter increases 7 mm over every one-meter distance traveled).

4.1.1.3 Figure: vi Series Beam Ellipticity

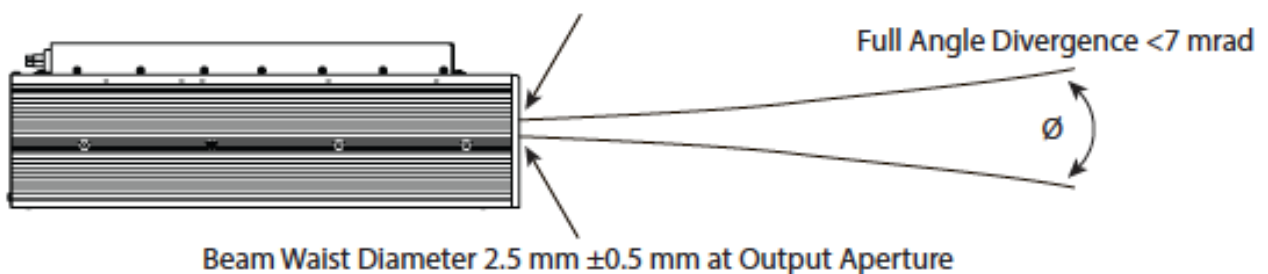

4.1.1.4 Internal RF Power Supply

The vi Series lasers are driven by a compact radio frequency (RF) oscillator mounted in the laser chassis. The 48 VDC input voltage is converted into a high-power RF signal using an RF power oscillator. The output from the RF oscillator (nominally at 83.5 MHz) drives the laser directly by exciting carbon dioxide (CO_2) gas in the tube to produce lasing.

4.1.1.5 Control Circuit

Sensors built into the OEM vi Series control board monitor the laser for conditions like under/over voltage, over temperature, and other faults that pose a risk of damage to the laser. The vi40 has temperature broadcasting capability (see section 4.3.4 vi40 Temperature Broadcast). Additionally, laser operation is controlled by a Laser Enable input.

4.1.2 Optical Setup

After selecting a laser for a CO₂ laser processing system, the two most crucial elements to consider are: (1) beam delivery optics to transmit the beam to the work area; and (2) focusing optics to focus the beam onto the part or material to be processed. Each element is crucial in the development of a reliable laser-based material processing system and each element should be approached with the same careful attention to detail.

4.1.2.1 Beam Delivery Optics

Divergence, or expansion, of the laser beam is important in materials processing since a larger beam entering the focusing optic produces a smaller focused spot. Because the vi Series laser beam diverges by 7 mm over each meter of distance traveled, the laser should be mounted a distance of 1.0–1.5 m (40–60 in) away from the work area and no closer than 0.75 m (30 in) for optimum performance. Right angle turning mirrors (beam benders) are often used in conjunction with the laser mounting position to obtain this distance.

Expander/collimators are optical devices that increase beam diameter by a selectable magnification factor while reducing beam divergence at the same time. Adding an expander/collimator reduces beam divergence and any variance in beam diameter caused by the changing optical path length in an XY (“flying optics”) table application. In fixed-length delivery systems where the laser is positioned only one meter away from the focusing optic and a small spot size is required, an expander/collimator is again the best solution to provide the required beam expansion before reaching the focusing optic.

4.1.2.2 Focusing Optics

When selecting a focusing optic, the primary consideration should be material thickness and any vertical tolerances that occur during final part positioning rather than selecting based only on minimum spot size. The chosen focal length should create the smallest possible focused spot while providing the depth of field required for the material being processed.

Optics are fragile and must be handled carefully, preferably by the mounting ring only. Be careful to select optics that are thick enough to withstand the maximum assist gas pressure available for the process. This is especially important in metal cutting applications using high-pressure assist gases.

Cleanliness is another principal issue affecting performance and becomes increasingly important as laser power increases. Dirty or scratched lenses will underperform, exhibit a vastly shortened lifetime, and may fail catastrophically.

When the application requires air (instead of nitrogen) as an assist gas, use only breathing quality air available in cylinders from a welding supply company. Compressed shop air contains minute particles of oil and other contaminants that will damage optical surfaces. If compressed shop air is the only choice

available, it must be filtered and dried to ISO 8573-1:2010 Class 1, 2, 1 specification as shown in the following table.

Important Note:

Optical components in the beam path must always be aligned to the actual beam path, not the laser faceplate. Because of slight variations in laser construction, the beam path may not always be centered in, or perpendicular to, the aperture in the faceplate.

4.1.2.3 Table: Assist Gas Purity Specifications

Assist Gas	Typical Purpose	Specification	
Air	Cutting/Drilling	Breathing Grade	> 99.9996% purity; filtered to ISO Class 1 Particulate level
Air	Cutting/Drilling	Compressed	Instrument-grade air filtered and dried to ISO 8573-1:2010 Class 1, 2, 1 (< 10 1.0µm particles/m ³ ; < 40 °F dew point; < 0.01 mg/m ³ oil vapor)
Argon	Welding	High Purity Grade	> 99.998% purity; filtered to ISO Class 1 particulate level
Helium	Welding	High Purity Grade	> 99.997% purity; filtered to ISO Class 1 particulate level
Nitrogen	Cutting/Drilling	High Purity Grade	> 99.9500% purity; filtered to ISO Class 1 particulate level
Oxygen	Cutting/Drilling	Ultra-pure Grade	> 99.9998% purity; filtered to ISO Class 1 particulate level

4.2 Controlling Laser Power

4.2.1 Control Signals

Much of the information provided in this section describes the use of a Novanta UC-2000 Universal Laser Controller to provide tickle and PWM Command signals to the vi Series laser. If using an alternate method of laser control, thoroughly review this section, *Controlling Laser Power*, as well as the following section,

DB-9 I/O Connections, for an understanding of the signal requirements necessary to control lasers. For more information about the UC-2000, please consult the UC-2000 Laser Controller Operator's Manual found on the Novanta website.

4.2.1.1 Tickle Pulses

Tickle pulses are signals that pre-ionize the laser gas to just below the lasing threshold so that a further increase in pulse width adds enough energy to the plasma to cause laser emission. Tickle pulses cause the laser to respond predictably and instantaneously to PWM Command signals, even when there are longer pauses (laser off time) between applied Command signals.

The vi Series lasers do not have an internal tickle signal; therefore, users must provide 1 μ s duration tickle pulses, at a frequency of 5 kHz, between applied PWM Command signals. Tickle pulses must be sent at the end of every 200- μ s interval in which a PWM Command signal is not applied.

4.2.1.2 Pulse Width Modulation (PWM)

Pulse Width Modulation, or PWM, controls laser power by varying the duty cycle of the laser's RF amplifiers, which in turn control the time-averaged RF power applied to the laser. Typically, laser output follows the PWM input with a rise and fall time constant of \sim 100 μ s; however, the laser cannot precisely follow PWM input signals if the "On" pulse is less than 100 μ s in duration. At a constant 50% duty cycle, vi Series lasers typically reach 90–100% of full optical output when operated at a frequency of 5 kHz and reach 65–80% optical output at 7 kHz. The percentage of optical output increases as duty cycle increases (at a constant PWM frequency) or as PWM frequency decreases (at a constant duty cycle). Figures 4.2.1.3 and 4.2.1.4 show representative vi Series optical output waveforms at two different PWM frequencies.

The vi Series lasers are designed to operate at Command signal base frequencies up to 100 kHz; however, the choice of PWM frequency depends on the user's specific application. In many laser applications, the UC-2000's default Command signal frequency of 5 kHz has proven to work well. For high-speed motion applications that cannot tolerate any ripple in the optical beam response but still need adjustable power levels, we recommend the use of higher PWM frequencies, up to 100 kHz maximum.



Warning: Serious Personal Injury

Always use shielded cable when connecting your PWM Command signal source to PWM Positive/PWM Negative inputs.

In electrically noisy environments, long lengths of unshielded wire act like an antenna and may generate enough voltage to trigger uncommanded lasing.

4.2.1.3 Figure: Typical Optical Output Pulse (50% Duty Cycle) at 3 kHz

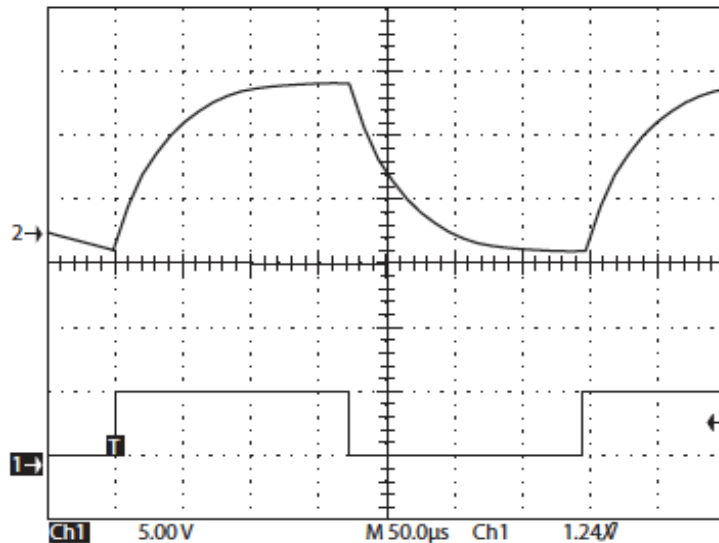

4.2.1.4 Figure: Typical Optical Output Pulse (50% Duty Cycle) at 5 kHz

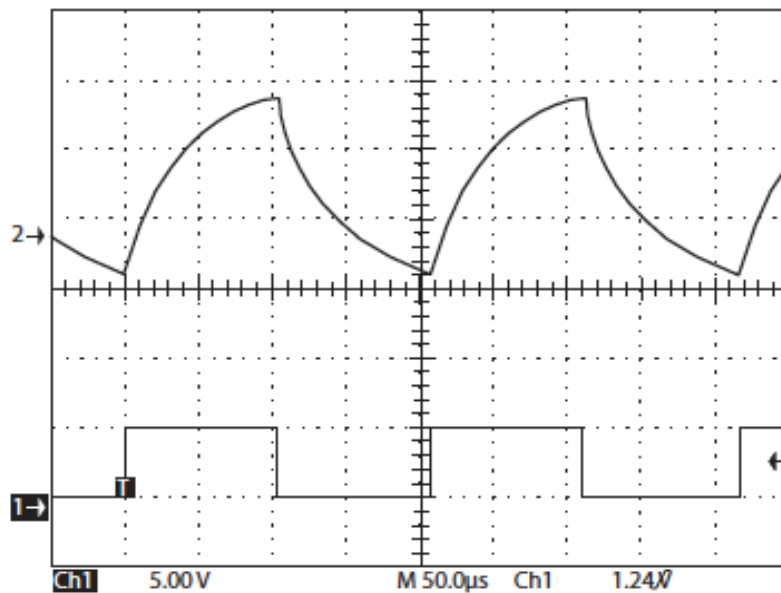

4.2.1.5 Command Signal

The modulated Command signal applied between Pin 1 (PWM Positive) and Pin 6 (PWM Negative) on either interface connector has three basic parameters: signal amplitude, base frequency, and PWM duty

cycle. By changing these parameters, you can command the beam to perform a variety of marking, cutting, welding, or drilling operations.

The first Command signal parameter, signal amplitude, is a square wave that is either logic low—corresponding to laser beam off, or logic high—corresponding to beam on. The laser off voltage, typically 0 V, can range from 0.0 V to +0.8 VDC while the laser on voltage, typically 5 V, can range from +3.5 V to +6.7 VDC.

Base frequency, the second parameter, is the repetition rate of the PWM input signal. The standard base frequency is 5 kHz, which has a period of 200 μ s. Maximum PWM frequency is 100 kHz.

The third Command signal parameter, PWM duty cycle, is the percentage of the period that the Command signal is high. If the Command signal’s amplitude (at 5 kHz) is high for 100 μ s and low for 100 μ s, it has a 50% duty cycle. If the amplitude is high for 190 μ s and low for 10 μ s, it has a 95% duty cycle. Figure 4.2.1.6 illustrates PWM Command signal parameters while Table 4.2.1.7 lists PWM signal specifications.

The vi Series DB-9 I/O PWM input consists of a high-speed optoisolator LED with a forward voltage drop (V_f) of 1.5 VDC. The PWM input frequency can range from DC (0 Hz) to 100 kHz. Table 4.2.1.7, below, provides minimum, maximum, and nominal PWM signal specifications.

Important Note:

Novanta lasers are designed for maximum performance at a 95% duty cycle. Increasing the maximum PWM percentage beyond 95% increases the laser’s heat load with little or no corresponding increase in laser output power.

4.2.1.6 Figure: PWM Command Signal Waveform

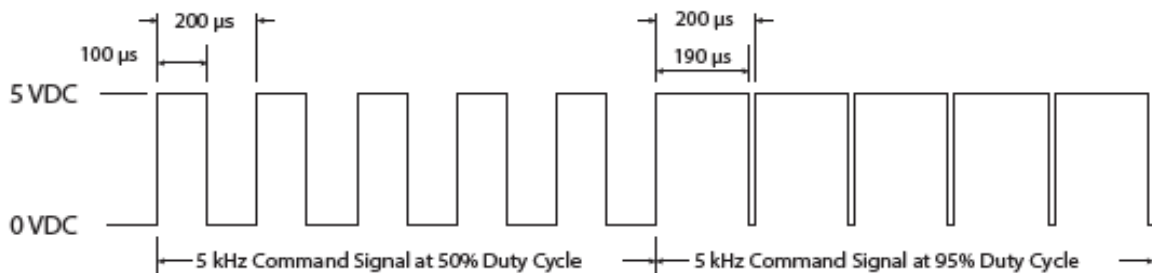

4.2.1.7 Table: PWM Command Signal Levels

Laser State	Minimum	Nominal	Maximum
Laser Off	0.0 VDC	0.0 VDC	+0.8 VDC
Laser On	+3.5 VDC (5 mA)	+5.0 VDC (9 mA)	+6.7 VDC (10 mA), continuous
Frequency Range	0 Hz (DC)	5 kHz	100 kHz
Duty Cycle	0%		100% (95% recommended)

4.2.2 Operating Modes

This section discusses external control, analog voltage or current control, continuous wave operation, and gated operation.

4.2.2.1 External Control

In addition to controlling the vi Series lasers using a UC-2000 Universal Laser Controller, there are other methods of external control. The two primary elements of laser control are gating, the ability to turn the laser on and off at the appropriate times, and power, the ability to control the laser's output energy. Both gating and power can be handled by a device such as a personal computer, Programmable Logic Controller (PLC), or function generator capable of providing tickle pulses in addition to sending PWM signals at the proper time (gating) and with the proper duty cycle (power).

4.2.2.2 Analog Voltage or Current Control

Although the vi Series lasers cannot be controlled directly by analog voltage or current signals, this type of control is possible when using the UC-2000 Controller. The Controller is connected normally to the laser, and analog voltage, or current signals sent to the UC-2000's ANV/C connector, then control both laser gating and power.

To generate the correct analog voltage for the UC-2000 Controller from a computer or PLC, a Digital-to-Analog (D/A or DAC) card capable of generating 0 V (laser off) to 10 V (maximum laser power) must be installed. To generate the proper analog current, install a D/A card that can generate 4 mA (laser off) to 20 mA (maximum power). Software able to control your analog output card is required for either configuration.

4.2.2.3 Continuous Wave (CW) Operation

In some applications, such as high-speed marking or cutting, the time constant of the laser and the PWM modulation causes a series of dots that may be visible on the marking surface instead of a “clean” line. Operating the laser in CW mode will prevent this behavior from occurring.

To operate the laser in CW mode, apply a constant +5 VDC signal to Pin 1 (PWM Positive) and Pin 6 (PWM Negative) on the DB-9 I/O connector. This constant voltage source forces the internal switching electronics to remain on, providing continuous and uninterrupted laser output power. During CW operation, output power cannot be changed. To adjust output power, refer to the Pulse Width Modulation (PWM) section for information regarding high frequency operation.



Warning: Serious Personal Injury

The UC-2000's default gate logic is factory set to internal Pull-Up (normally on) mode so that an open (disconnected) Gate input causes the laser to turn on. This functionality allows the user to easily test and verify laser operation prior to integration.

In an integrated system, you should configure the UC-2000's gate input logic to internal Pull-Down (normally off) mode. This prevents the beam from being enabled unless a high level (+3.5 V to +5.0 VDC) signal is applied to the Gate input connector. In the Pull- Down (normally off) mode an asserted logic low signal, short circuit to ground, or an open or disconnected Gate inputs locks the beam off.

4.2.2.4 Gated Operation

In many marking and cutting applications, the laser is required to pulse, or gate, on and off in synchronization with an external control signal (typically from a computer or function generator operating in the range from DC to 1 kHz). To pulse or gate the laser, connect a signal providing +5.0 VDC pulses to the Gate connector on the rear panel of the UC-2000.

Users who intend to use a gating signal should set the UC-2000's gate input logic to internal Pull-Down (normally off) mode. This prevents the beam from being enabled unless a high level (+3.5 V to +5.0 VDC) signal is applied to the Gate input connector. In the pull-down (normally off) mode, an asserted logic low signal, short circuit to ground, or an open or disconnected Gate input locks the beam off.

Many CO₂ lasers operating in applications requiring short gating pulses at repetition rates below 500 Hz will exhibit some leading-edge overshoot regardless of the PWM frequency. This occurs because a cooler lasing medium (the CO₂ gas) is more efficient than a hotter one. The overshoot effect is more pronounced at lower gating frequencies since the gas has a longer time to cool down between Command signal pulses.

4.3 DB-9 I/O Connections

4.3.1 DB-9 I/O Connector

The DB-9 I/O connector provides a +5 VDC auxiliary output (DC Out), a PWM input, an enable input, and four status outputs. The user inputs, Laser Enable and PWM Positive/PWM Negative, enable lasing and provide output power control. User outputs indicate laser ready, lase, over temp, and input voltage status. The vi Series laser PWM inputs are optoisolated; however, all other inputs and outputs operate using standard 5V logic levels (0V – logic low; 5V – logic high). Both inputs and outputs are ESD protected but are not optoisolated; all input signals sent to the laser must be clean or conditioned by the user. The figure below illustrates the pin arrangement of the DB-9 I/O (9-pin female D-type subminiature) connector on the vi Series' rear panel while the following table provides connection descriptions.

4.3.1.1 Figure: DB-9 I/O Connector Pinouts

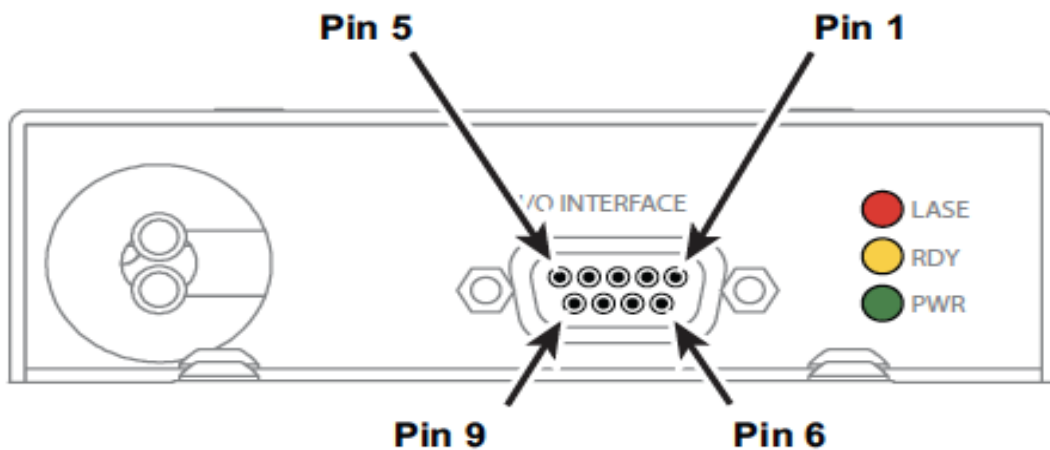

4.3.1.2 Table: DB-9 I/O Pin Descriptions

Pin	Description	Function
1	PWM Positive Input	Use this optoisolated voltage input for tickle and PWM signals referenced to PWM Negative (Pin 6). The tickle signal is a +5 VDC, 1 μ s pulse at 5 kHz while the PWM Command signal is a +5 VDC, 5 kHz nominal (100 kHz max) pulse width modulated square wave.
2	Laser Ready output	This output is logic high (+5 V) when the laser is ready to lase (RDY indicator illuminated yellow). The output is low (0 V) when the laser is disabled (RDY indicator Off). The Laser Ready output sources 20 mA typical, 40 mA maximum.
3	Lase Indicator output	This output is logic high (+5 V) when the laser is actively lasing (LASE indicator illuminated red). The output is low (0 V) when the laser is not lasing (LASE indicator Off). The Lase Indicator output sources 20 mA typical, 40 mA maximum.
4	Overtemp Fault Output (vi30) Temperature Broadcast Signal (vi40)	On the vi30 laser, this output goes logic high (+5V) when an over temperature fault condition is detected, causing the RDY indicator to flash continuously. When the laser is operating within the normal temperature range, this output is at 0V. This output sources 20 mA typical, 40 mA maximum. On the vi40 laser, this output provides the Temperature Broadcast Signal. See the vi40 Temperature Broadcast section.
5	DC Out output	This connection provides a +5 VDC, 250 mA maximum user output voltage referenced to GND (Pin 8). For example, this voltage can be jumpered, or switched, to drive the Laser Enable input.
6	PWM Negative input	This input provides the negative, or return, side of the optoisolated tickle/PWM Command signal referenced to PWM Positive (Pin 1).
7	DC Voltage Fault output	This output is logic high (+5 V) if the DC input voltage is under or over voltage limits (PWR indicator flashes a sequence of 2 blinks, pauses 1/2 second, and then repeats). The output is low (0 V), when DC input voltage is within limits. The DC Voltage Fault output sources 20 mA typical, 40 mA maximum.
8	GND	This connection is the ground, or return, point for all signals except PWM Positive.
9	Laser Enable input	When this input is logic high (+5 V), the laser is enabled (RDY indicator illuminates yellow). The laser is disabled when the input is low (0 V). After this input goes high, a five-second delay occurs before tickle or PWM signals are applied to the RF circuit.

4.3.2 Input Circuitry



Warning: Serious Personal Injury

Always use shielded cable when connecting your PWM Command signal source to PWM Positive/PWM Negative inputs.

In electrically noisy environments, long lengths of unshielded wire act like an antenna and may generate enough voltage to trigger uncommanded lasing.

4.3.2.1 Figure: Input Equivalent Schematic

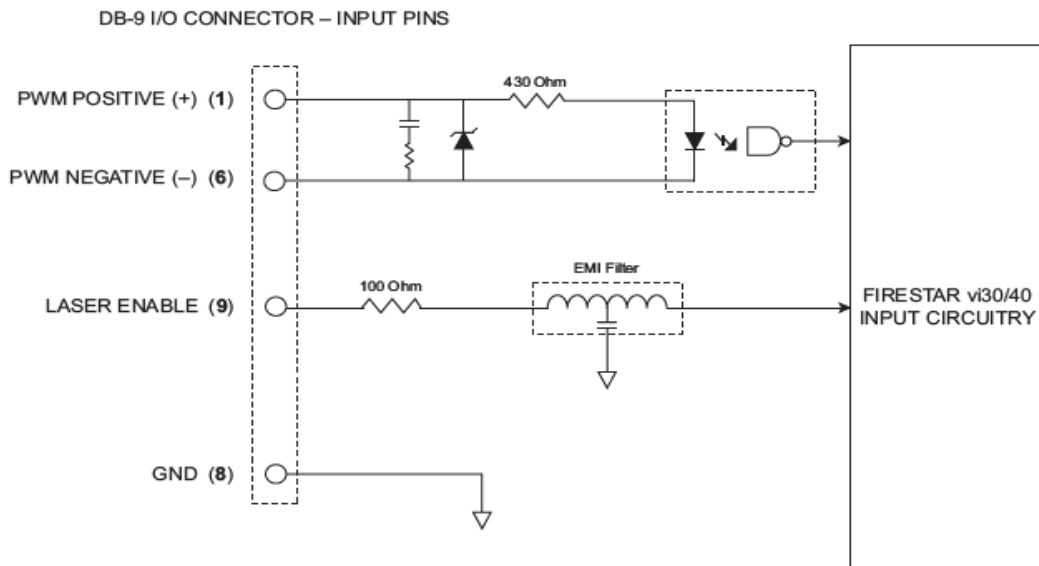

4.3.2.2 Table: Input Circuit Specifications

Input Signals	Input device type and specifications
PWM Positive Input	High-speed optoisolator LED, forward voltage drop (V _f) 1.5 VDC Off state V _{max} +0.8 VDC On state V _{min} +3.5 VDC @ 5 mA On state (continuous) V _{max} +6.7 VDC @ 10 mA Frequency, max. 100 kHz

Laser Enable	5V logic input buffer Off state $V_{max} +0.8$ VDC On state $V_{min} +2.0$ VDC @ 0.2 mA On state (continuous) $V_{max} +5.0$ VDC @ 0.5 mA
--------------	--

Important Note:

Do not apply a Laser Enable signal until the vi Series laser internal +5 VDC power supply has stabilized (approximately 200 ms after DC power-up).

Caution: Possible Equipment Damage

The Laser Enable input is a direct 5V logic input. Do not send a voltage signal to the Laser Enable input (Pin 9) until DC power is applied; otherwise, the control board will be damaged.

Observe all 5V logic specifications and precautions when integrating vi Series laser inputs and outputs into your control system.

4.3.2.3 Sample Input Circuits

The following figures illustrate methods of applying Laser Enable signals.

Figure: vi30 Powered Laser Enable Circuit illustrates one method of applying the Laser Enable signal using a customer-supplied limit switch or relay contact powered by the vi Series laser DC Out output (+5 V, 250 mA).

Figure: Customer Powered Laser Enable Circuit shows another variation for applying a Laser Enable signal. In this case, the customer is also supplying the voltage necessary to drive the vi Series laser enable circuit.

Figure: PLC Switched Laser Enable Circuit shows an isolated PLC output module switching the Laser Enable signal from a +5 V source.

4.3.2.3.1 Figure: vi30 Powered Laser Enable Circuit

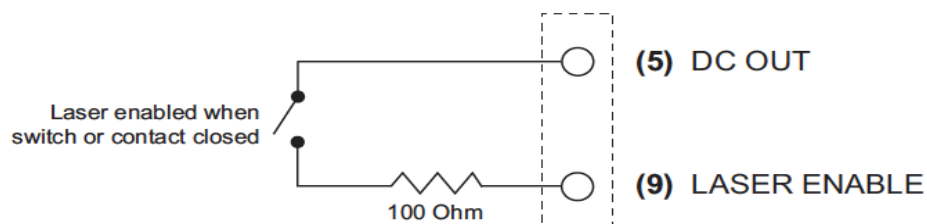

4.3.2.3.2 Figure: Customer Powered Laser Enable Circuit

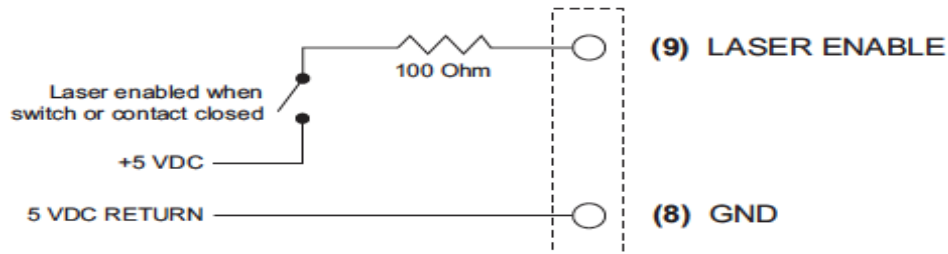

4.3.2.3.3 Figure: PLC Switched Laser Enable Circuit

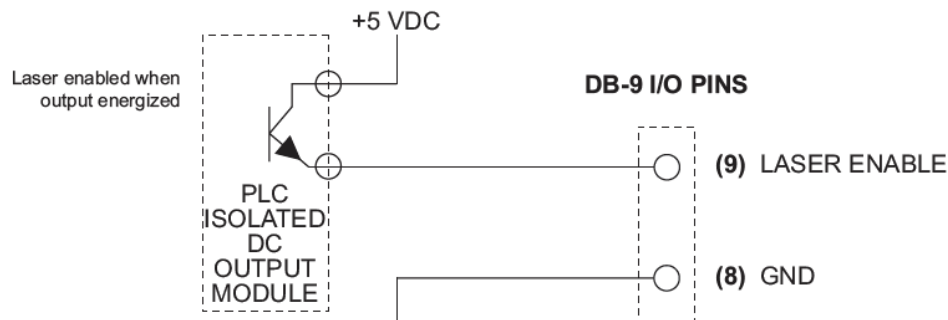

4.3.3 Output Circuitry

The vi Series lasers have four user outputs that communicate laser status to the user's control system. As described in the following table, the four outputs, Laser Ready, Lase Indicator, Over Temp Fault, and DC Voltage Fault are ESD protected, but are not optoisolated. The Laser Ready output goes high (+5V) when lasing is possible, otherwise the output is low (0V) when the laser is not ready. Lase Indicator goes high when the PWM signal is sufficient to induce laser output and is low when no beam is being emitted. Over Temp Fault goes high when laser temperature rises above its upper thermal limit; otherwise, the output is low. DC Voltage Fault goes high when an under/over voltage condition is sensed; otherwise, the output is low when the DC supply voltage is within limits.

Note:

The vi Series laser outputs are voltage sources. Each output can source only 20 mA typical, 40 mA maximum, to a ground referenced load (the ground reference, GND, is Pin 8). The control board will be damaged if this current limit is exceeded.

The vi Series lasers also include a +5 VDC output voltage source, DC Out. This output can provide a maximum current of 250 mA and is useful for driving the Laser Enable input as described in the Input circuitry subsection.

The table below provides vi Series output circuit specifications while the figure on the following page illustrates the output circuit's equivalent internal schematic.

4.3.3.1 Table: Output Circuit Specifications

Output Signals	Output device type and specifications
Laser Ready	5V logic output buffer
Laser Enable	On state $V_{min} +4.5$ VDC @ 50 mA
Over-temp Fault	On state (typical) +5.0 VDC @ 0.5 mA
DC voltage Fault	Off state $V_{max} +0.8$ VDC

4.3.3.2 Figure: Output Equivalent Schematic

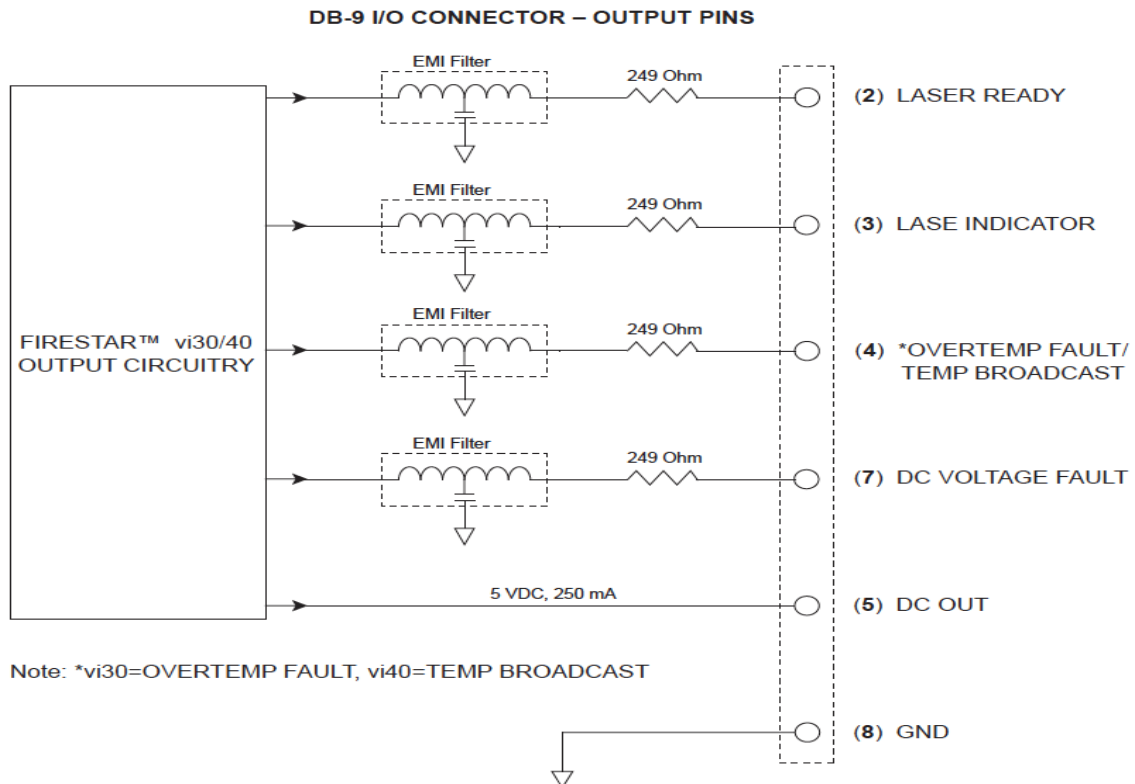

4.3.3.3 Sample Output Circuit

You can monitor the vi Series laser status remotely by connecting one or more outputs to an isolated 5 VDC solid state relay or PLC input module. The figure below illustrates the connections required to monitor the vi30's Lase Indicator status, or any other vi30 output, using an isolated 5 VDC input module.

4.3.3.4 Figure: Lase Indicator Output to PLC Input

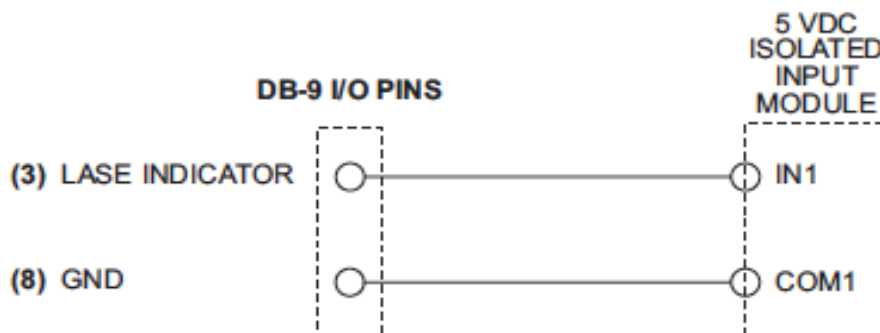

4.3.4 vi40 Temperature Broadcast

The vi40 lasers are equipped with a Temperature Broadcast Feature, which provides users the ability to monitor the laser's internal temperature status.

The temperature data is:

- indicated in decreed Celsius (°C)
- transmitted as 13-bit serial data packets through pin 4 (referenced to pin 8) of the laser's DB-9 I/O connector
- transmitted as values ranging from 0 to 125 °C and a resolution of 0.0625°C per bit

4.3.4.1 Synchronous Data Transmission

Data transmission of the vi40 temperature output line is synchronous and follows a set of rules:

1. The start of the data bit must always be high for 3.90625ms.
2. The end of the data bit must always be low for 3.90625ms.
3. One data bit period is 15.625ms (64Hz).
4. The end of each data packet must always be low for a rest period of 250ms

4.3.4.2 Figure: Synchronous Transmission of a Single Bit

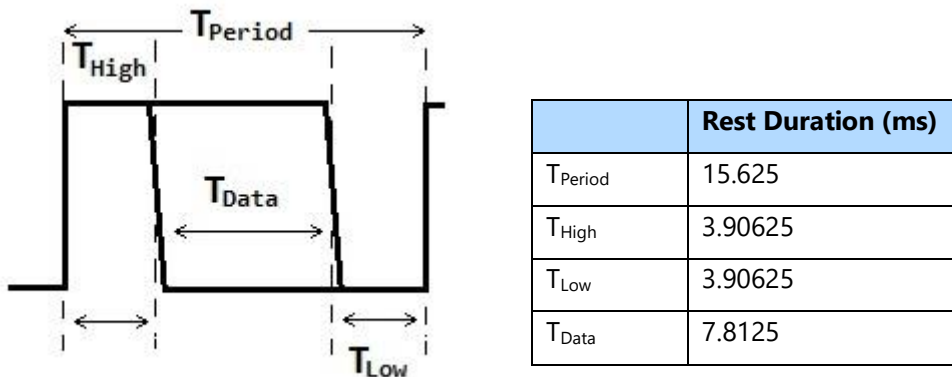

The figure above shows the protocol for the synchronous transmission of a single bit. The rising edge of the output signal indicates the start of a data bit and the level must remain high for the time indicated by T_{High} . Data is transmitted next and this value can either be logic high or low. The time provided for the data value to be read is indicated by T_{Data} . After the data bit, the signal is pulled low (if data is high) or stayed low to indicate the end of bit. The signal must remain low for the duration of the time indicated by T_{Low} . The signal is repeated for the next bit to be transmitted. At the end of the data stream, there is a rest period to indicate the end of a transmission packet. The duration of the rest period is indicated by T_{Rest} , shown in the following figure. A rising edge signal after the rest period indicates a start of a new data packet and the data bit transmission method is repeated.

4.3.4.3 Figure: Rest Period

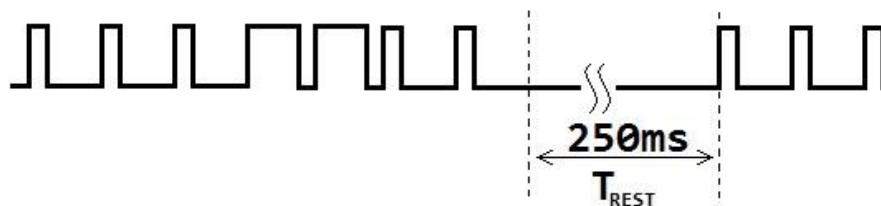

4.3.4.4 Temperature Reading

The temperature data has a 13-bit format. There are 12 bits to represent the temperature value plus an additional bit to indicate whether the number is positive or negative. The temperature measurement has a resolution of 0.0625 Celsius per bit and has a range from zero to +125 Celsius.

The first bit of transmission is the signed bit for negative temperatures. (Note: the vi40 limits the temp readings to above 0°C.) The next 8 bits of data represents the binary temperature value in 1°C increments.

The last 4 bits of data represents the binary temperature value in 0.0625°C increments. See the following figure and table for examples.

4.3.4.5 Figure: Example Output for Measurement of 25.5°C

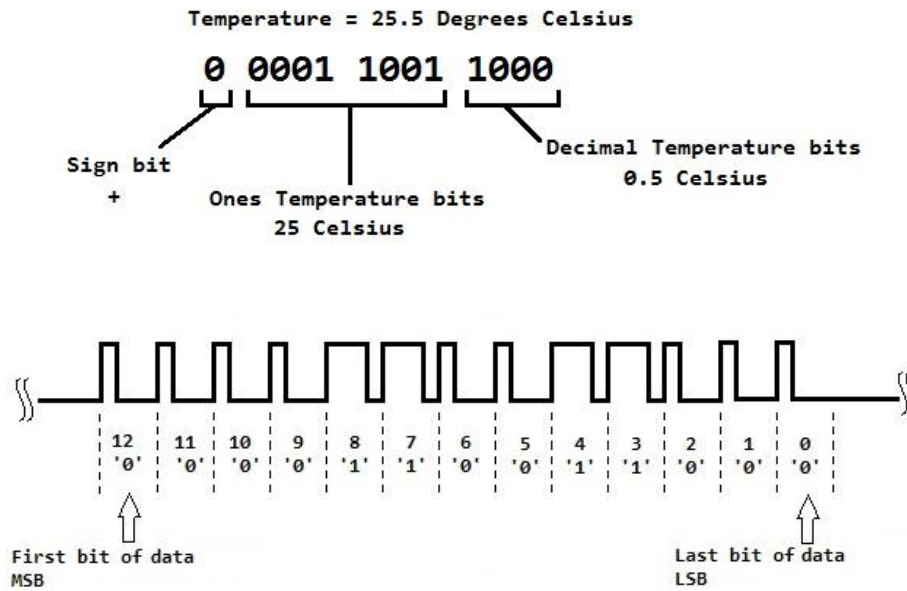

4.3.4.6 Table: Example Temperature Measurements

Temperature (Celsius)	Corresponding Data Output
+125	0 0111 1101 0000
+25	0 0001 1001 0000
+0.0625	0 0000 0000 0001
0	0 0000 0000 0000

4.4 General Specifications

4.4.1 vi Series General Specifications

Output Specifications	vi30 (9.3 μm)	vi30 (10.2 μm)	vi30 (10.6 μm)	vi40 (10.6 μm)
Wavelength typical (μm)	9.23-9.31	10.2-10.3	10.6 \pm 0.03 ⁹	
Average Power Output continuous ² (minimum)	20 W	25 W	30 W	40 W
Power Stability, guaranteed/after 2 min ³ (typ)	\pm 7% / \pm 5%	\pm 5% / \pm 3%		
Mode Quality M ²	\leq 1.2			
Beam Waist Diameter, mm (at 1/e ²)	2.5 \pm 0.5			
Beam Divergence, full angle, mrad (at 1/e ²)	< 7.0			
Ellipticity	< 1.2			
Polarization	Linear, horizontal			
Rise Time	<100 μs			

Input Specifications	vi30	vi40
Power Supply		
Voltage	48 VDC \pm 2.0 VDC	
Maximum Current ⁵	10A (11A peak for < 1ms)	15A (17A peak for < 1ms)
Input Signals		
Tickle Signal / PWM Command Signal		
Voltage (5V nominal)	+3.5 to +6.7 VDC / +3.5 to +6.7 VDC	
Current	10 mA @ +6.7 VDC / 10 mA @ +6.7 VDC	
Frequency	5 kHz (1 μs duration) / DC-100kHz	

Cooling Specifications	vi30	vi40
Maximum Heat Load	500 Watts	680 watts
Maximum Chassis Temperature	vi30 70 °C (158 °F)	70 °C (158 °F)
Minimum Flow Rate	140 CFM per fan (two fans required)	190 CFM per fan (two fans required)

Environmental Specifications	vi30	vi40
Operating Ambient Temperature Range ⁴	15 °C-40 °C	15 °C-45 °C
Humidity	0-95%, non-condensing	

Physical Specifications	vi30 (dual)	vi30 (air)	vi40 (air)
Length	18.12 in (46.57 cm)	16.80 in (42.67 cm)	
Width	3.495 in (8.89 cm) ⁸		
Height	5.46 in (13.87 cm) ^{6,7}		
Weight	15.00 lbs (6.80 kg)	14.30 lbs (6.49 kg)	14.80 lbs (6.71 kg)

* Specifications subject to change without notice.

- 1 This power level is guaranteed for 12 months regardless of operating hours.
- 2 48 VDC input voltage to obtain guaranteed output power.
- 3 Guaranteed from cold start at 5kHz, 95% duty cycle. Value after 2 minutes typical.
- 4 Published specifications guaranteed at a temperature of 22 °C. Some performance degradations may occur in ambient temperatures above 22 °C. For air-cooled lasers, laser power typically decreases 0.5–1% per degree Celsius increase in ambient temperature.
- 5 For <1ms @ 100Hz, 50% duty cycle.
- 6 Mounting feet will add 1/4 in (0.64 cm) to overall height.
- 7 Tall models, add 1/4 in (0.64 cm) to overall height.
- 8 Wide models, add the width of the mounting feet for an overall width of 4.58 in (11.633 cm).
- 9 Typical. Actual wavelength may vary from 10.2 - 10.8 μm.

4.5 Outline & Mounting Drawings

4.5.1 Figure: vi30 Air-Cooled (OEM) Outline and Mounting Dimensions

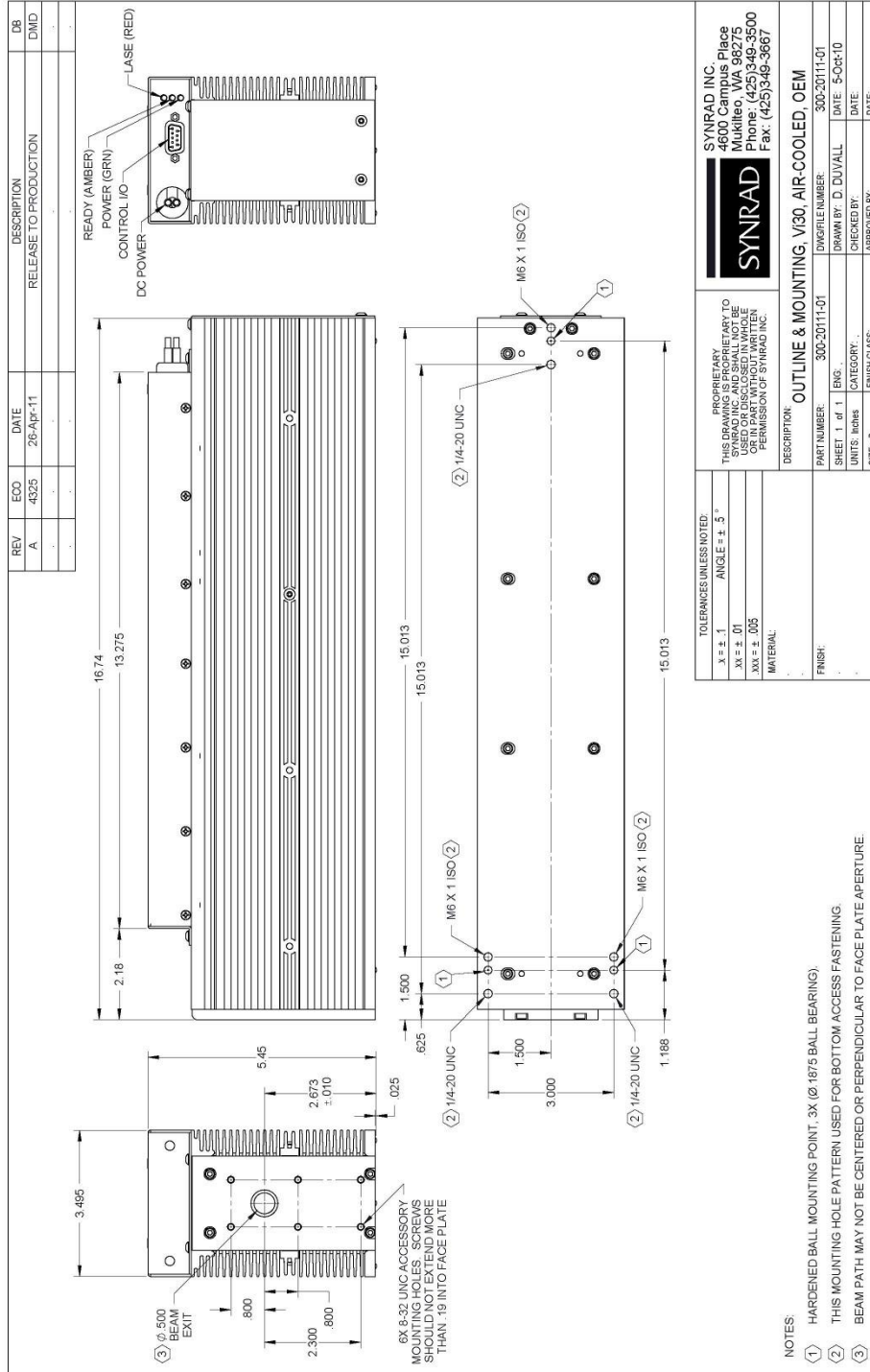

4.5.1.1 Figure: vi30 Outline and Mounting Dimensions – with Optional Customer-Installed “Tall” Mounting Feet

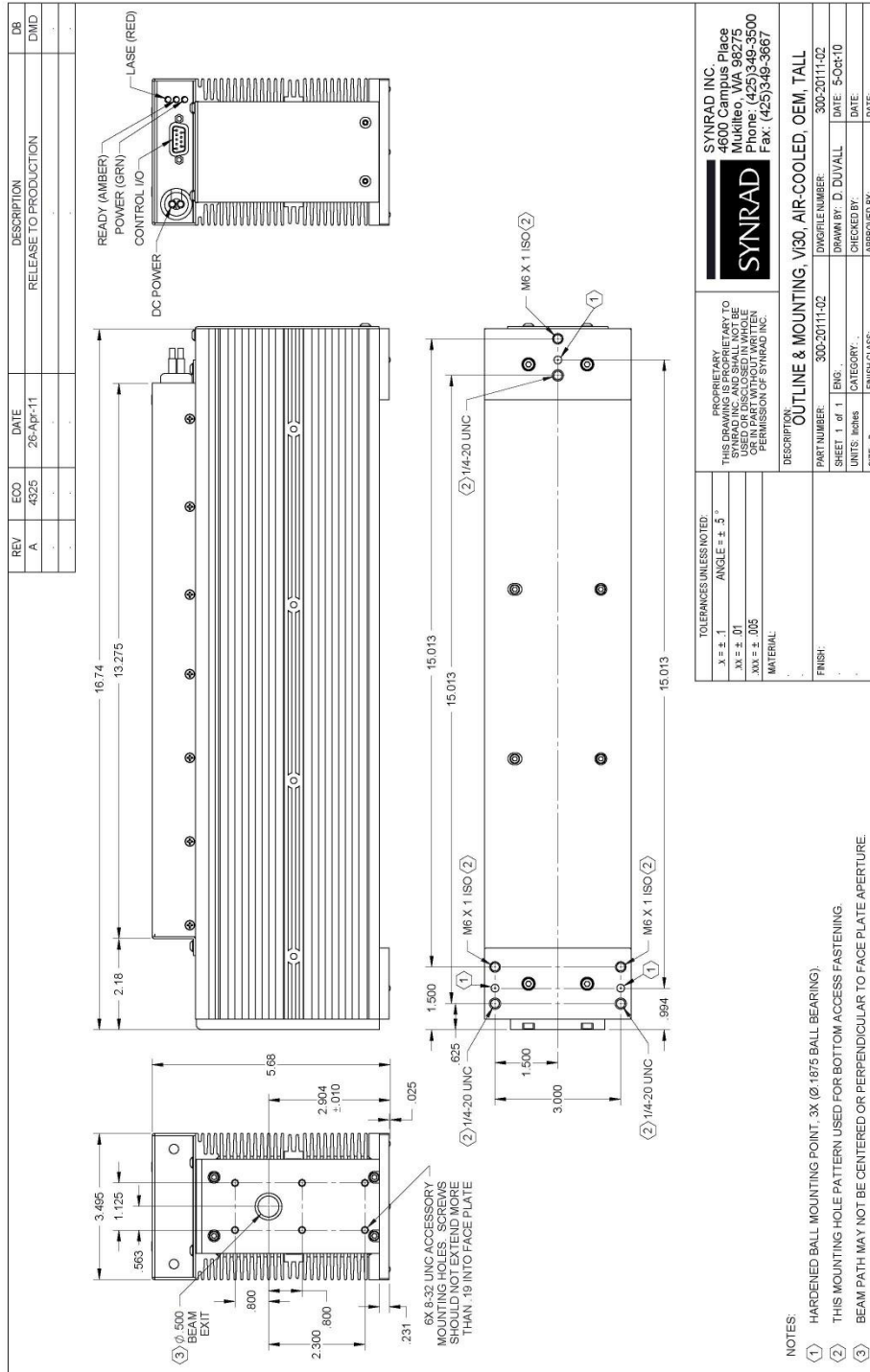

4.5.2 Figure: vi30 Water-Cooled Outline and Mounting Dimensions

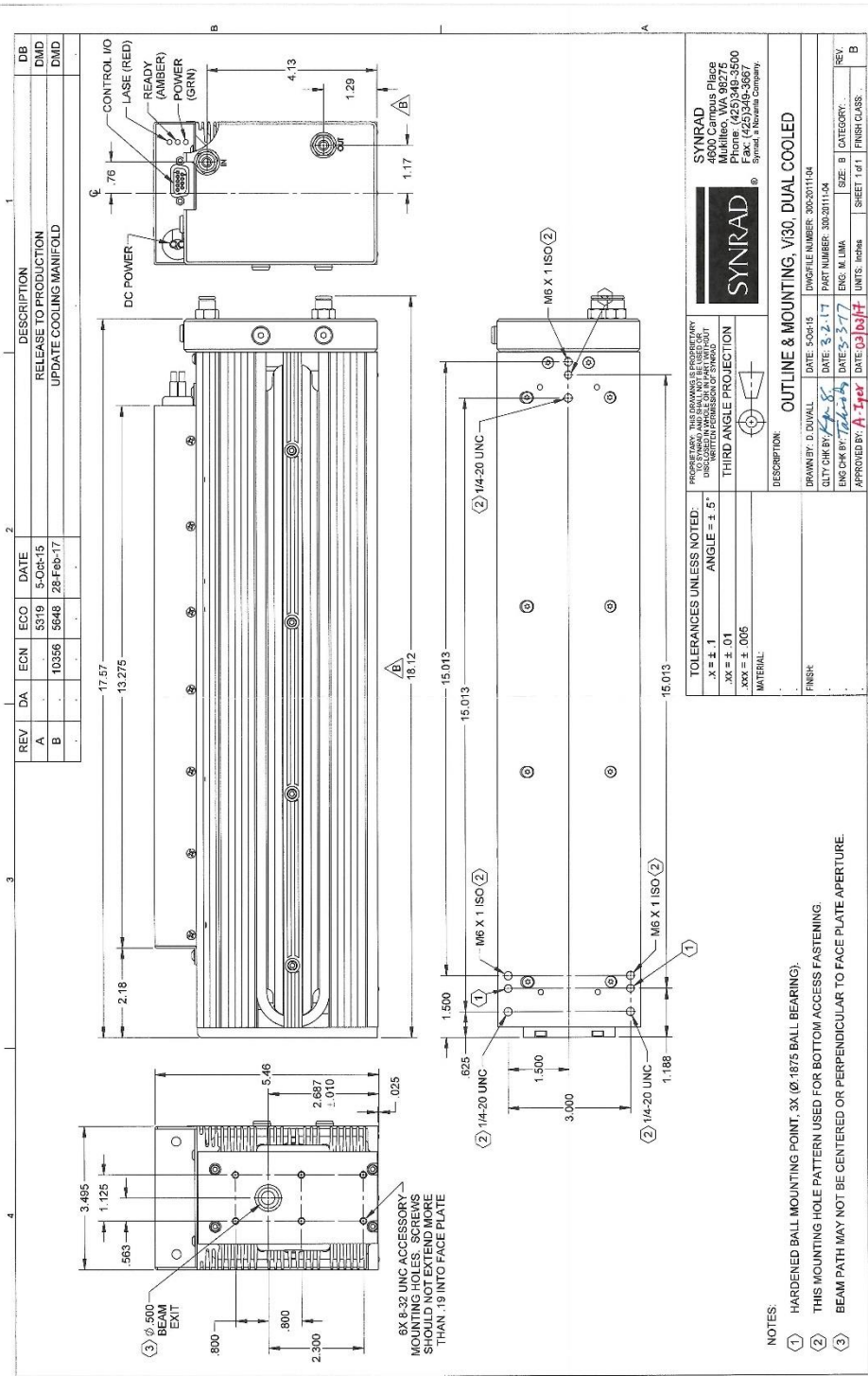

4.5.4 Figure: vi Series Packaging Instructions

REV	DA	ECN	ECO	DATE	DESCRIPTION	DB
A			4325	25-Apr-11	RELEASE TO PRODUCTION	DND
B			4564	23-May-12	UPDATE DESCRIPTION	DND
C		10447	5736	11-Aug-17	ADD V40	DND

STEP BY STEP PACKAGING INSTRUCTIONS:

- POSITION BOX SO LOGO ON TOP FLAP IS FACING YOU (LOGO WILL BE ON THE LEFT SIDE).
- PLACE LASER INSIDE FOAM CAVITIES AS SHOWN, MAKING SURE FRONT OF LASER IS ON THE LEFT SIDE AND LOGO OF LASER IS FACING YOU.
- PLACE LASER INSIDE FOAM CAVITIES AS SHOWN, MAKING SURE FRONT OF LASER IS ON THE LEFT SIDE AND LOGO OF LASER IS FACING YOU. NOTE: CABLES NOT SHOWN FOR EASE OF ILLUSTRATION.
- PLACE TOP FOAM OVER LASER AS SHOWN.
- TUCK CABLE AS SHOWN.
- DO NOT SWITCH THE LASER ON. A SWITCH TO AVOID DAMAGE TO KEYSWITCH.
- DO NOT SHIP THE LASER WITH A SWITCH TO AVOID DAMAGE TO KEYSWITCH.
- WRITE SYNTRAD RETURN AUTHORIZATION NUMBER ON OUTSIDE OF SHIPPING BOX.

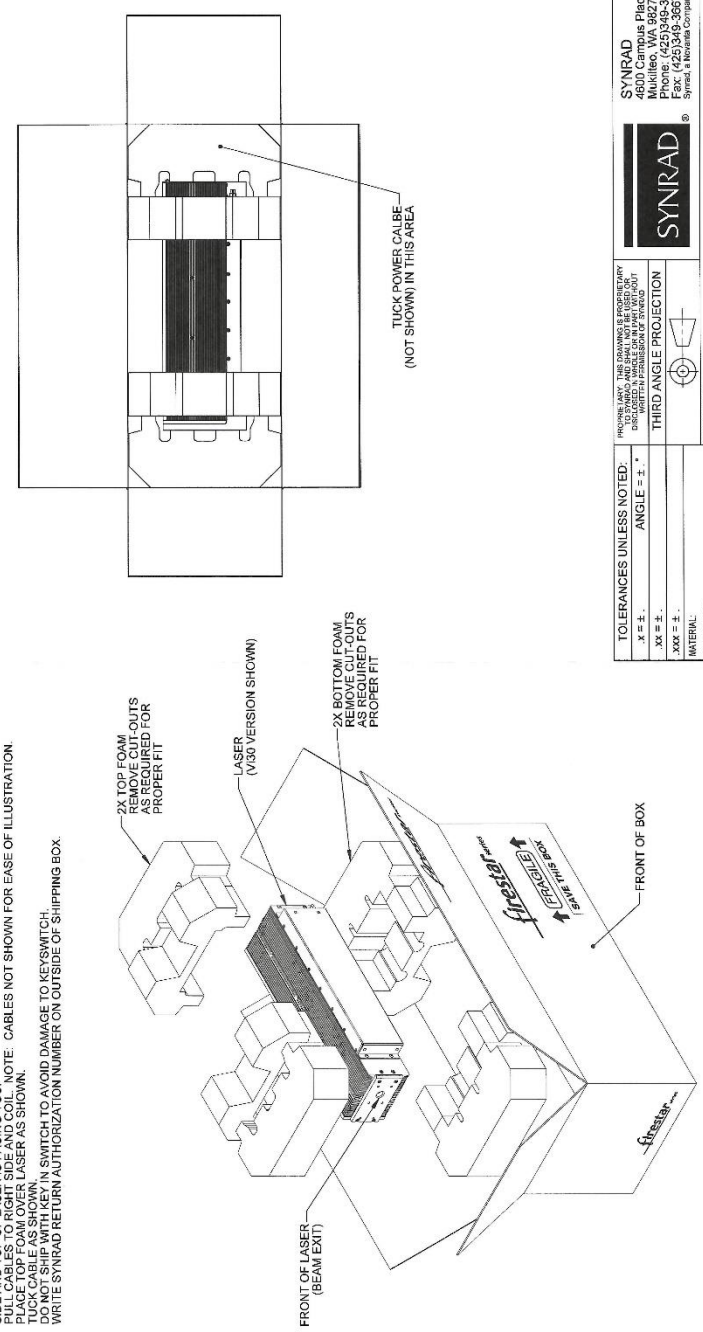

TOLERANCES UNLESS NOTED:

.X ± .X
 .XX ± .X
 .XXX ± .X

ANGLE = ± .X

THIRD ANGLE PROJECTION

MATERIAL:
SEE BOM

FINISH:

SYNTRAD
 4800 Campus Place
 Milwaukee, WI 53212-1500
 Phone: (414) 251-3450
 Fax: (414) 349-3667
 Synrad, a Novanta Company.

DESCRIPTION: **PACKAGING V30(V30V40)**

DRAWN BY: D.DUVAL DWG FILE NUMBER: 90-20277-01
 DATE: 28-Apr-11

CHECKED BY: *K.V. Kelly* DATE: 28-Apr-11
 PART NUMBER: 90-20277-01

ENG. CHK BY: *T. Kelly* DATE: 28-Apr-11
 ENG. DATE: 28-Apr-11

APPROVED BY: *H. Kelly* DATE: 28-Apr-11

UNITS: Inches SHEET 1 of 1 FINISH CLASS: C

IMPORTANT NOTE: FAILURE TO PROPERLY PACKAGE LASER USING SYNTRAD SHIPPING BOX AND FOAM/CARDBOARD INSERTS AS SHOWN MAY VOID WARRANTY. CUSTOMERS MAY INCUR ADDITIONAL REPAIR CHARGES DUE TO SHIPPING DAMAGE CAUSED BY IMPROPER PACKAGING.

5 Maintenance and Troubleshooting

Use information in this chapter to perform maintenance or troubleshoot your vi Series laser.

5.1 Maintenance

5.1.1 Disabling the Laser

Before performing any maintenance on your vi Series laser, be sure to completely disable the laser by disconnecting the DC Power Cables from the DC power supply.

5.1.2 Daily Inspections

Perform the following steps daily to keep your vi Series laser in optimum operating condition. Except for the procedures described below, no other service is required or should be attempted.



Warning: Serious Personal Injury

A risk of exposure to toxic elements, like zinc selenide, may result when certain optical or beam delivery components are damaged. In the event of damage to laser or beam delivery optics, contact our technical support team (see section 1.6 Technical Support) or the optics manufacturer for proper handling instructions.

Caution: Possible Equipment Damage

For optics in the beam path, even small amounts of contamination can absorb enough energy and damage the optic. Inspect beam delivery optics periodically for signs of contaminants and carefully clean as required. In dirty environments, purge laser optics using filtered air or nitrogen to prevent vapor and debris from accumulating on optical surfaces.

If you plan to operate your laser in dirty or dusty environments, please contact our technical support team for more information about the associated risks, as well as precautions that you can take to increase the longevity of the laser and optical components.

1. Inspect all cooling tubing connections for signs of leakage. Check for signs of condensation that may indicate the cooling water temperature has been set below the dew point temperature. Condensation will damage electrical and optical components inside the laser. See the Setting Coolant Temperature

section in the Getting Started chapter, and the Technical Reference chapter for details on preventing condensation.

2. Inspect beam delivery components for signs of dust or debris and clean as required. When cleaning the optical surfaces of beam delivery components, carefully follow the manufacturer's instructions.
3. Visually inspect the exterior housing of the laser to ensure that all warning labels are present. Refer to the Laser Safety chapter for label types and locations

5.1.3 Storage/Shipping

When preparing the laser for storage or shipping, remember to drain cooling water from the laser. In cold climates, any water left in the cooling system may freeze, which could damage internal components. After draining thoroughly, use compressed shop air at no more than 200 kPa (29 PSI)—Wear safety glasses! —to remove any residual water. When finished, cap all connectors to prevent debris from entering the cooling system.

When shipping Novanta lasers to another facility, we highly recommend that you ship the unit in its original Novanta shipping container. If you no longer have the original shipping box and inserts, contact Novanta Customer Service about purchasing replacement packaging. Refer to vi Series Packaging Instructions in the Technical Reference section for detailed instructions on properly packaging the laser for shipment.

Important Note

Failure to properly package the laser using Novanta-supplied shipping boxes and foam/cardboard inserts as shown in the Packaging Instructions section may void the warranty. Customers may incur additional repair charges for shipping damage caused by improper packaging.

5.1.4 Cleaning Optical Components

Debris or contaminants on external beam delivery components may affect laser processing and lead to damage or failure of the optics and/or the laser. Carefully follow the steps below to inspect and clean the optical components in the beam path. Before beginning the cleaning process, read this entire section thoroughly to ensure that all cleaning materials are available and that each step is completely understood.

**Danger: Serious Personal Injury**

Ensure that DC power to the laser is turned off and locked out before inspecting optical components in the beam path. Invisible CO2 laser radiation is emitted through the aperture. Corneal damage or blindness may result from exposure to the laser radiation.

Caution: Possible Equipment Damage

Because of their smaller beam diameter, the vi Series lasers have significantly higher power densities than most of our other lasers. This means that any contamination of the laser's output window (or on any optic in the beam path) can absorb enough energy to damage the optic. Inspect the output window and other beam delivery optics periodically for signs of contaminants and carefully clean as required. In dirty environments, purge laser optics using filtered air or nitrogen to prevent vapor and debris from accumulating on optical surfaces.

Important Note

Exercise great care when handling infrared optics; they are much more fragile than common glass materials. Optical surfaces and coatings are easily damaged by rough handling and improper cleaning methods.

5.1.4.1 Cleaning Guidelines

- Wear latex gloves or finger cots (powder-free) to prevent contamination of optical surfaces by dirt and skin oils.
- Never handle optics with tools; always use gloved hands or fingers.
- Hold optics by the outer edge; never touch the coated surface.
- Always place optics on a tissue or suitable equivalent material for protection; never place optics on hard or rough surfaces.
- It may be necessary to use a cotton ball or fluffed cotton swab instead of a lens wipe to uniformly clean the entire surface of small-diameter mounted optics.
- Before using any cleaning agents, read Material Safety Data Sheets (MSDS) and observe all necessary safety precautions.

5.1.4.2 Table: Required Cleaning Materials

The table below lists the type and grade of materials required to properly clean optical surfaces.

Cleaning Material	Requirement
Latex gloves or finger cots	Powder-free
Air bulb	Clean air bulb
Ethyl or isopropyl alcohol	Spectroscopic or reagent grade
Acetone	Spectroscopic or reagent grade
Lens wipe (preferred)	Optical (clean-room) quality
Cotton balls or cotton swabs	High-quality surgical cotton / high-quality paper bodies

5.1.4.3 Cleaning Optics

1. Shut off and lock out all power to the laser. You must verify that the laser is OFF (in a zero-energy state) before continuing with the optical inspection!
2. Visually inspect all optical surfaces in the beam path for contaminants.

Caution: Possible Lens Damage

Do not allow the nozzle of the air bulb to touch the optical surface. Any contact may damage the optic by scratching coatings on the optical surface.

Do not use compressed shop air to blow contamination from the optic. Compressed air contains significant amounts of water and oil that form adsorbing films on the optical surface.

Do not exert pressure on the surface of the optic during cleaning. Optical surfaces and coatings are easily scratched by dislodged contaminants.

Use a new lens wipe on each pass as contaminants picked up by the wipe may scratch the optical surface.

3. Remove loose contaminants from the optic by holding a clean air bulb at an angle to the optic and blow a stream of air at a glancing angle across the lens surface. Repeat, as necessary.
4. Dampen a lens wipe with the selected cleaning agent. Alcohol (least aggressive) is best for initial surface cleaning. Acetone (moderately aggressive) is best for oily residue or minor baked-on vapors and debris.

Important Note:

If acetone is used as a cleaning solvent, a second follow-up cleaning of the optical surface using alcohol is required

5. Gently, and without applying pressure, drag the damp lens wipe across the optical surface in a single pass. **Do not rub or apply any pressure**, especially when using a cotton swab. Drag the wipe without applying any downward pressure. Use a clean lens wipe on each pass. The wipe will pick up and carry surface contaminants that may scratch optical surfaces or coatings.

Note:

Use a clean lens wipe on each pass. The wipe will pick up and carry surface contaminants that may scratch optical surfaces or coating.

To prevent streaking during the final alcohol cleaning, drag the lens wipe slowly across the surface so that the cleaning liquid evaporates right behind the wipe.

6. Carefully examine the optic under suitable lighting. Certain contaminants or damage such as pitting cannot be removed. In these cases, the optic must be replaced to prevent catastrophic failure.
7. Repeat Steps 4 through 6 as required, removing all traces of contaminants and deposits.

5.2 Troubleshooting

5.2.1 Introduction

The Troubleshooting section is designed to help isolate problems to the module level only. Problems on circuit boards or the laser tube are outside the scope of this guide because they are not user-serviceable assemblies; do not attempt to repair them. Contact Novanta or a Novanta Authorized Distributor for repair information.

To troubleshoot vi Series lasers, it is necessary to understand the sequence of events that must happen before the laser can operate. Before attempting any service, we advise you to read the entire troubleshooting guide and review both the operational flowchart and the functional block diagram.

**Danger: Serious Personal Injury**

This Class 4 laser product emits *invisible* infrared laser radiation in the 9.3 – 10.6 μm CO₂ wavelength band, depending on model.

Direct or diffuse laser radiation can inflict severe corneal injuries leading to permanent eye damage or blindness. All personnel must wear eye protection suitable for 9.3 – 10.6 μm CO₂ radiation when in the same area as an exposed laser beam. Eyewear protects against scattered energy but is not intended to protect against direct viewing of the beam – never look directly into the laser output aperture or view scattered laser reflections from metallic surfaces.

Do not contact the laser beam. This product emits an invisible laser beam that is capable of seriously burning human tissue. Always be aware of the beam's path and always use a beam block while testing.

Caution: Possible Equipment Damage

Attempting repair of a Novanta laser without the express authorization of Novanta will void the product warranty.

If troubleshooting or service assistance is required, please contact Technical Support (see section 1.6).

5.2.2 Figure: Operational Flowchart

The following figure illustrates the vi Series laser's start up sequence

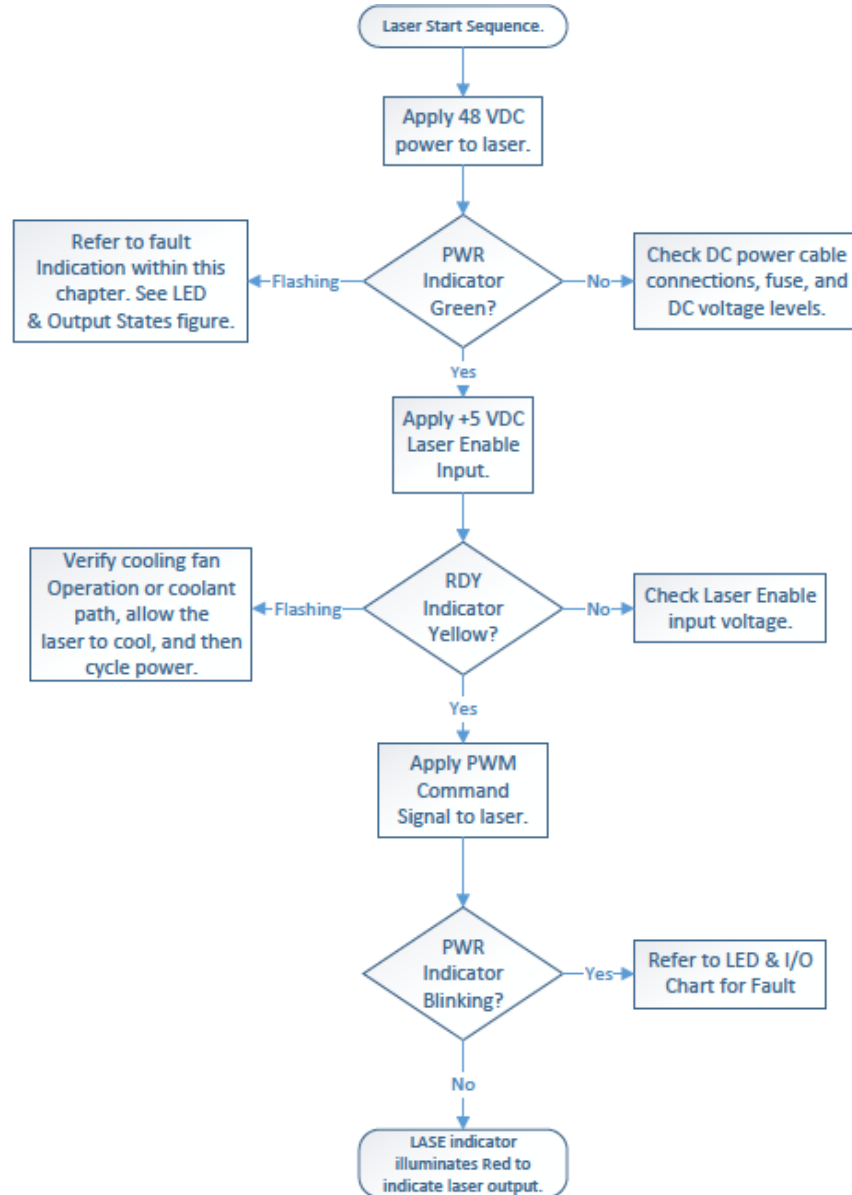

5.2.3 Status Indicator LEDs

Three status indicator LEDs on the rear of the vi Series laser provide a visual indication of operating status.

1. A green PWR LED illuminates when DC power is applied to the laser.
2. The yellow RDY LED indicates that a Laser Enable signal has been applied and that, after a five-second delay, lasing will begin once a PWM Command signal is received.
3. The LASE LED illuminates red to indicate that the PWM signal is sufficient to induce laser output.

In conjunction with the DB-9 I/O outputs, these status LEDs also provide information on fault conditions.







































5.2.4 Laser Fault Indicators

The vi Series lasers can indicate five specific fault conditions. In the event of certain faults, the RDY LED, PWR LED or both will blink an error code, pause 1/2 second, and then repeat the code. This sequence continues until the fault is corrected and the laser is reset by cycling DC power to the laser.

See the following table for a summary of LED indicator and output signal states during normal and fault conditions.

5.2.5 Table: vi Series Input I/O Status States

LED and I/O States, vi-Series Lasers

LASER CONDITION / FAULT	INPUT STATUS		LED STATUS	OUTPUT STATUS					COMMENTS	
	Laser Enable	PWM		Laser Ready	Over Temp*	Temperature**	DC Voltage Fault	Laser Active		
PIN #	9	1 to 6		2	4	4	4	7	3	Except for PWM, all I/O referenced to pin 8
DC Power Off	X	X	  	L	L	L	L	L	L	No RF to tube
DC Power Applied Laser Not Enabled	0	X	  	L	L	L		L	L	No RF to tube
DC Power Applied Laser Enabled	1	0	  	H	L	L		L	L	Tickle applied to tube for 5 seconds, then laser may fire
Laser Firing	1		  	H	L	L		L	H	Normal laser operation with PWM active
Over Temperature	1	X	  	L	H	L		L	L	Chassis temperature > 60°C
Under Voltage	1	X	  	L	L	L		H	L	P/S Voltage < 45VDC
Over Voltage	1	X	  	L	L	L		H	L	P/S Voltage > 52VDC
DC Sense	1	X	  	L	L	L		L	L	Laser service required
PWM Drive Fault	1	X	  	L	L	L		L	L	Laser service required
TABLE KEY:										
0 = Input OFF (0.8V max)										
1 = Input ON (2.0V min)										
X = Does not matter										
   Blinking LED # = blink pattern C = continuous blink										
L = Low (0.8V max)										
H = High (4.5V min)										
* = vi30 only										
** = vi40 only										

5.2.6 Resetting Faults

5.2.6.1 Over Temperature Fault

Over temperature faults occur when thermal limits in the laser are exceeded (RDY indicator flashes continuously; PWR LED remains solid green). To reset an over temperature fault, cool laser chassis temperature below 60 °C and then cycle DC power. When the RDY LED illuminated without flashing, lasing is enabled.

5.2.6.2 Under Voltage Fault

An under-voltage fault occurs when the DC input voltage is at or below 45 VDC. This fault is indicated by the PWR indicator flashing 1 blink at 1/2 second intervals. To reset an under voltage fault, ensure that 48 VDC is applied to the laser under full-load conditions and then cycle DC power. When PWR and RDY indicators illuminate, lasing is enabled.

Under voltage faults are typically caused by the DC power supply being unable to properly regulate output voltage under full-load or high inrush current conditions. Improper regulation may be caused by an undersized DC supply or insufficient AC line voltage.

5.2.6.3 Over Voltage Fault

An over voltage fault occurs when the DC input voltage is at or above 52 VDC. This fault is indicated by the PWR indicator flashing 2 blinks at 1/2 second intervals. To reset an over voltage fault, ensure that 48 VDC is applied to the laser under full-load conditions and then cycle DC power. When PWR and RDY indicators illuminate, lasing is enabled.

5.2.6.4 DC Sense Fault

The DC Sense fault is indicated by the PWR indicator flashing 3 blinks at 1/2 second intervals. If this fault occurs, the laser requires service—contact Novanta or a Novanta Authorized Distributor.

5.2.6.5 PWM Sense / Control Board Fault

A PWM Sense or control board fault is indicated by both RDY and PWR indicators flashing continuously. If this fault occurs, the laser requires service—contact Novanta or a Novanta Authorized Distributor.

5.2.7 Other Laser Faults

When a laser fault occurs, the status LEDs and output signals will reflect a fault condition as indicated in the previous table. Each Symptom listed below described a particular fault. For each Symptom, specific causes and solutions are described under Possible Causes.

Symptom: The following LED and I/O states exist:

- LASE LED = Off Lase Indicator output = Low (0V)
- RDY LED = **Off** Laser Ready output - = **Low (0V)**
- PWR LED = Green
- Over Temp Fault output = Low (0V)
- DC Voltage Fault output = Low (0V)

Possible Causes:

- The Laser Enable input is not active.

A +5V Laser Enable signal must be applied between Pin 9 (Laser Enable) and Pin 8 (GND) on the DB-9 I/O connector to enable lasing.

Symptom: The following LED and I/O states exist:

- LASE LED = Off Lase Indicator output = Low (0V)
- RDY LED = **Flashing** Laser Ready output - = **Low (0V)**
- PWR LED = Green
- Over Temp Fault output = **High (+5V)**
- DC Voltage Fault output = Low (0V)

Possible Causes:

- An over temperature fault exists.

Cool the laser chassis temperature to below 60 dec C and then cycle DC power to the laser.

Symptom: The following LED and I/O states exist:

- LASE LED = Off Lase Indicator output = Low (0V)
- RDY LED = Off Laser Ready output - = **Low (0V)**
- PWR LED = **1-blink code**
- Over Temp Fault output = **Low (0V)**
- DC Voltage Fault output = **High (+5V)**

Possible Causes:

- An under voltage fault exists

An under voltage fault occurs when input voltage drops below 45 VDC for more than 420 ms. Check that the DC power supply is supplying +48 VDC under load and that its current capacity is 10 amperes or greater. After correcting the problem, cycle DC power to reset the fault.

- An under voltage condition exists (DC power supply is current-limiting)

An under voltage condition occurs because PWM signals were applied before tube breakdown occurred. After correcting the problem, cycle DC power to reset the fault. On cold start, verify that tickle pulses are being sent to the laser for a period of 5 to 10 seconds **before** a PWM signal is applied.

Symptom: The following LED and I/O states exist:

- LASE LED = Off Lase Indicator output = Low (0V)
- RDY LED = Off Laser Ready output - = **Low (0V)**
- PWR LED = **2-blink code**
- Over Temp Fault output = Low (0V))
- DC Voltage Fault output = **High (+5V)**

Possible Causes:

- An over voltage fault exists

An over voltage fault occurs when input voltage is above 52 VDC for more than 420 ms. Check that the DC power supply is supplying +48 VDC under load. After correcting the problem, cycle DC power to reset the fault.

Symptom: The following LED and I/O states exist:

- LASE LED = Off Lase Indicator output = Low (0V)
- RDY LED = Off Laser Ready output - = **Low (0V)**
- PWR LED = **3-blink code**
- Over Temp Fault output = Low (0V))
- DC Voltage Fault output = **High (+5V)**

Possible Causes:

- DC Sense fault has occurred

If this fault occurs, the laser requires service. Contact Novanta or an authorized Novanta distributor. See 1.5 General Inquiries.

Symptom: The following LED and I/O states exist:

- LASE LED = Off Lase Indicator output = Low (0V)
- RDY LED = **Flashing** Laser Ready output - = **Low (0V)**
- PWR LED = **Flashing**
- Over Temp Fault output = Low (0V))
- DC Voltage Fault output = Low (0V)

Possible Causes:

- A PWM Sense fault or control board failure has occurred

If this fault occurs, the laser requires service. Contact Novanta or an authorized Novanta distributor. See 1.5 General Inquiries.

Symptom:

- The built in +5 VDC, 250 mA voltage output on Pin 5, DC Out, has been accidentally shorted to ground

Possible Causes:

- In the event that Pin 5, DC Out, is shorted to ground, the laser will not be damaged as the voltage regulator is protected by a current limiting circuit.

Symptom:

- The power supply is connected, and the voltage is correct, but the PWR LED is not on.

Possible Causes:

- The fast-acting fuse has blown.

To replace the fuse, open the in-line fuse holder by twisting the upper half ¼-turn counter-clockwise. Remove the fuse and replace it with an appropriate fast-acting fuse. A replacement fuse is included in the laser shipment kit. See table 3.2.3 in the Getting Started Chapter for more information on the shipment inventory.

5.2.8 Beam Delivery Optics



Warning: Serious Personal Injury

The use of aerosol dusters containing difluoroethane causes “blooming,” a condition that significantly expands and scatters the laser beam. This beam expansion can affect mode quality and/or cause laser energy to extend beyond the confines of optical elements in the system, damaging acrylic safety shielding. Do not use air dusters containing difluoroethane in any area adjacent to CO2 laser systems because difluoroethane persists for long time periods over wide areas.

Caution: Possible Equipment Damage

If you plan to operate your laser in dirty or dusty environments, please contact our technical support team for more information about the associated risks, as well as precautions that you can take to increase the longevity of the laser and optical components.

Symptom:

- The laser loses power over time
- Laser output power must be increased to maintain previous performance.

Possible Causes:

- Beam delivery optics are coated by vapor residue or debris



Danger: Serious Personal Injury

Ensure that DC power is turned off and locked out before inspecting optical components in the beam path. **Invisible** CO2 laser radiation is emitted through the aperture. Corneal damage or blindness may result from exposure to laser radiation.

Shut down the laser and carefully inspect each optic in the beam delivery path, including the laser’s output coupler. Remember that optics are fragile and must be handled carefully. If the optic requires cleaning, then refer back to the Maintenance section for cleaning instructions. Use only recommended cleaning materials (see 5.1.4.2 Required Cleaning Materials) to prevent scratching delicate optical surfaces.

**Warning: Serious Personal Injury**

A risk of exposure to toxic elements, like zinc selenide, may result when certain optical or beam delivery components are damaged. In the event of damage to the laser, marking head, or beam delivery optics, contact Novanta or the optics manufacturer for handling instructions.

If the focusing optic is pitted, it must be replaced immediately. Because of the extremely high power density of the vi Series lasers, pits or debris on the lens may absorb enough energy from the focused beam to crack the lens. If this happens other optics in the beam path may become contaminated as well.

When the application requires air (instead of nitrogen) as an assist gas, we recommend the use of breathing quality air available in cylinders from a gas welding supply company. Because compressed shop air contains minute particles of oil and other contaminants that will damage optical surfaces, it must be carefully filtered and dried before use as a purge or assist gas. Refer to 4.1.2.3 Assist Gas Purity Specifications in the Technical Reference chapter for filtering and drying specifications.

This page is intentionally left blank



Engineered by Synrad, part of Novanta

© 2025, Novanta Corporation. All rights reserved.

4600 Campus Place
Mukilteo, WA 98275
USA

www.novantaphotonics.com

V1 Revision A
January 2025