



SYNRAD PS-48-4000 DC Power Supply (Meanwell RKP-4K1UT-CMU1-48)

AC Input (1 Phase 180-264 VAC)

AC Input Connections:

- *Connect AC Ground (earth) to terminal labeled \perp
- *Connect AC Hot L1 to terminal labeled "L" on both inputs A and B
- *Connect AC Hot L2 to terminal labeled "N" on both Input A and B

AC Input (3 Phase 208 VAC)

AC Input Connections:

- *Connect AC Ground (earth) to terminal labeled \perp
- *Connect AC Hot L1 to terminal labeled "N" on both inputs A and B
- *Connect AC Hot L2 to terminal labeled L on AC Input A
- *Connect AC Hot L3 to terminal labeled L on AC Input B

DC Input (+12 VDC)

DC Input Connections:

- *Insert Barrel Connector of supplied DB-25 connector into DC input (power for RKP-CMU1 control and monitoring unit)
- *Connect DB-25 connector to CN500 I/O port

DC Output (+48 VDC)

DC Output Connections:

- *Connect DC Positive (red wire) to the Positive (+) 48 VDC terminal
- *Connect DC Return (black wire) to the Negative (-) terminal

Fig. 1. Power I/O

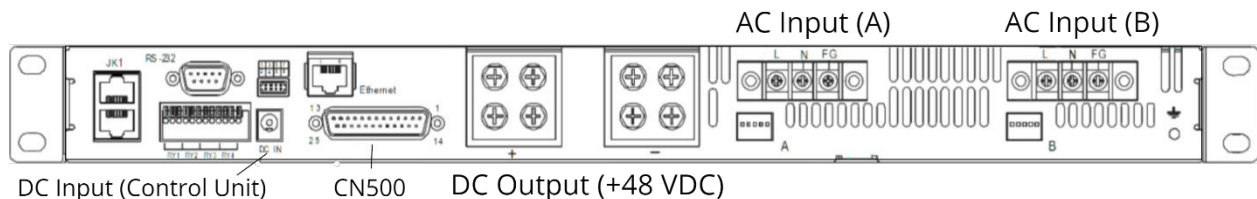

SYNRAD

SYNRAD PS-48-4000 DC Power Supply (Meanwell RKP-4K1UT-CMU1-48)



2000W Front End Power Supply

RCP-2000 series



■ Features :

- Universal AC input / Full range
- Built-in 5V/0.3A, 12V/0.8A auxiliary power
- Built-in active PFC function, PF>0.98
- High efficiency up to 92%
- Withstand 300VAC surge input for 5 seconds
- Protections: Short circuit / Overload / Over voltage / Over temperature
- High Power density 21.4W/inch³
- Forced air cooling by built-in DC fan with fan speed control
- Low profile:1U height
- Remote control for single unit
- Built-in remote sense function
- Output voltage trimming function
- Hot-swap operation
- PMBus serial communication
- AC OK, DC OK signal, fan fail, OTP alarm signal
- Internal OR-ing FET
- 3 years warranty

■ Description :

The RCP-2000 series are state of the art AC/DC frond-end rectifiers with 1U compact size and 21.4 W/in³ of high power density. They can provide up to 2000W per unit for the applications of servers, information technology equipment, networking, telecommunications, and wide range of industrial applications using distributed power architecture. Equipped with hot-swap function and PMBus communication protocol, RCP-2000 can be assembled in 1U 19 rack and controlled/monitored by external device such as monitoring unit (RCP-CMU-1) or PC.



SPECIFICATION - Single Unit

MODEL	RCP-2000-12		RCP-2000-24		RCP-2000-48		
OUTPUT	DC VOLTAGE	12V	24V	48V			
	RATED CURRENT	100A	80A	42A			
	CURRENT RANGE	0 ~ 100A	0 ~ 80A	0 ~ 42A			
	RATED POWER	1200W	1920W	2016W			
	RIPPLE & NOISE (max.) Note.2	150mVp-p	200mVp-p	300mVp-p			
	VOLTAGE ADJ. RANGE	10.5 ~ 14V	21 ~ 28V	42 ~ 56V			
	VOLTAGE TOLERANCE Note.3	±2.0%	±1.0%	±1.0%			
	LINE REGULATION	±1.0%	±0.5%	±0.5%			
	LOAD REGULATION	±1.0%	±0.5%	±0.5%			
	SETUP, RISE TIME	1500ms, 60ms/230VAC at full load					
HOLD UP TIME (Typ.)	16ms/230VAC at 75% load		10ms/230VAC at full load				
INPUT	VOLTAGE RANGE Note.5	90 ~ 264VAC	127 ~ 370VDC				
	FREQUENCY RANGE	47 ~ 63Hz					
	POWER FACTOR (Typ.)	0.98/230VAC at full load					
	EFFICIENCY (Typ.)	86%	90.5%	92%			
	AC CURRENT (Typ.)	13A/115VAC	7A/230VAC	16A/115VAC	10A/230VAC	16A/115VAC	10A/230VAC
	INRUSH CURRENT (Typ.)	COLD START 50A					
LEAKAGE CURRENT	<1.1mA / 230VAC						
PROTECTION	OVERLOAD	105 ~ 125% rated output power Protection type : Constant current limiting, unit will shut down o/p voltage after 5 sec. re-power on to recover					
	OVER VOLTAGE	14.7 ~ 17.5V	29.5 ~ 35V	57.6 ~ 67.2V			
	OVER TEMPERATURE	Shut down o/p voltage, recovers automatically after temperature goes down					
FUNCTION	AUXILIARY POWER	5V @ 0.3A, 12V @ 0.8A					
	REMOTE ON/OFF CONTROL	By electrical signal or dry contact ON:short OFF:open					
	REMOTE SENSE	Compensate voltage drop on the load wiring up to 0.5V					
	DC OK SIGNAL	The isolated TTL signal out, refer to function manual					
	AC OK SIGNAL	The isolated TTL signal out, refer to function manual					
	OUTPUT VOLTAGE TRIM	Adjustment of output voltage, possible between 90 ~ 110% of rated output					
	OVER TEMP WARNING	Logic " High" for over temperature warning, refer to function manual, isolated signal					
	FAN FAIL SIGNAL	The isolated TTL signal out, refer to function manual					
ENVIRONMENT	WORKING TEMP.	-40 ~ +70°C (Refer to "Derating Curve")					
	WORKING HUMIDITY	20 ~ 90% RH non-condensing					
	STORAGE TEMP., HUMIDITY	-40 ~ +85°C, 10 ~ 95% RH					
	TEMP. COEFFICIENT	±0.03%/°C (0 ~ 50°C)					
VIBRATION	10 ~ 500Hz, 2G 10min./1cycle, 60min. each along X, Y, Z axes						

File Name:RCP-2000-SPEC 2013-11-01

4600 Campus Place • Mukilteo, WA 98275 • (425) 349-3500 • Fax (425) 349-3667

Rev B / Oct 19 2015 P/N 900-20975-01

SYNRAD

SYNRAD PS-48-4000 DC Power Supply (Meanwell RKP-4K1UT-CMU1-48)



2000W Front End Power Supply

RCP-2000 series

MODEL	RCP-2000-12	RCP-2000-24	RCP-2000-48
SAFETY & EMC (Note 4)	SAFETY STANDARDS	UL60950-1, TUV EN60950-1 approved	
	WITHSTAND VOLTAGE	I/P-O/P:3KVAC I/P-FG:2KVAC O/P-FG:0.7KVDC	
	ISOLATION RESISTANCE	I/P-O/P, I/P-FG, O/P-FG:100M Ohms / 500VDC / 25°C / 70% RH	
	EMC EMISSION	Compliance to EN55022 (CISPR22) Conduction Class B, Radiation Class A ; EN61000-3-2,-3	
OTHERS	EMC IMMUNITY	Compliance to EN61000-4-2,3,4,5,6,8,11, EN61000-6-2 (EN50082-2), heavy industry level, criteria A	
	MTBF	60.1K hrs min. MIL-HDBK-217F (25°C)	
	DIMENSION	295*127*41mm (L*W*H)	
	PACKING	2Kg,6pcs/13Kg/1.04CUFT	
NOTE	<ol style="list-style-type: none"> All parameters NOT specially mentioned are measured at 230VAC input, rated load and 25°C of ambient temperature. Ripple & noise are measured at 20MHz of bandwidth by using a 12" twisted pair-wire terminated with a 0.1uf & 47uf parallel capacitor. Tolerance : includes set up tolerance, line regulation and load regulation. The power supply is considered a component which will be installed into a final equipment. The final equipment must be re-confirmed that it still meets EMC directives. Derating may be needed under low input voltages. Please check the static characteristics for more details. Output of all the RCP-2000 modules are connected in parallel in the rack. Under parallel operation of more than one rack connecting together, ripple of the output voltage may be higher than the SPEC at light load condition. It will go back to normal ripple level once the output load is more than 10%. 		

■ Mechanical Specification (Single Unit) Case No. 974A Unit:mm

Input / Output Connector Pin No. Assignment(CN501) : Postronic PCIM34W13M400A1

Pin No.	Assignment	Pin No.	Assignment	Pin No.	Assignment	Pin No.	Assignment	Pin No.	Assignment	Pin No.	Assignment	Mating Housing
1,2,3,4	+V	12	DA	17	ON/OFF	22	NC	27	T-ALARM	32	FG \pm	Postronic PCIM34W13F400A1
5,6,7,8	-V	13	DB	18	A1	23	SDA	28	FAN-FAIL	33	AC/L	
9	-V(signal)	14	+S	19	A2	24	SCL	29	+5V-AUX	34	AC/N	
10	+V(signal)	15	-S	20	A3	25	AC-OK	30	+12V-AUX			
11	PV	16	A0	21	A4	26	DC-OK	31	GND-AUX			

File Name:RCP-2000-SPEC 2013-11-01

4600 Campus Place • Mukilteo, WA 98275 • (425) 349-3500 • Fax (425) 349-3667

Rev B / Oct 19 2015 P/N 900-20975-01

SYNRAD PS-48-4000 DC Power Supply (Meanwell RKP-4K1UT-CMU1-48)



2000W Front End Power Supply

RCP-2000 series

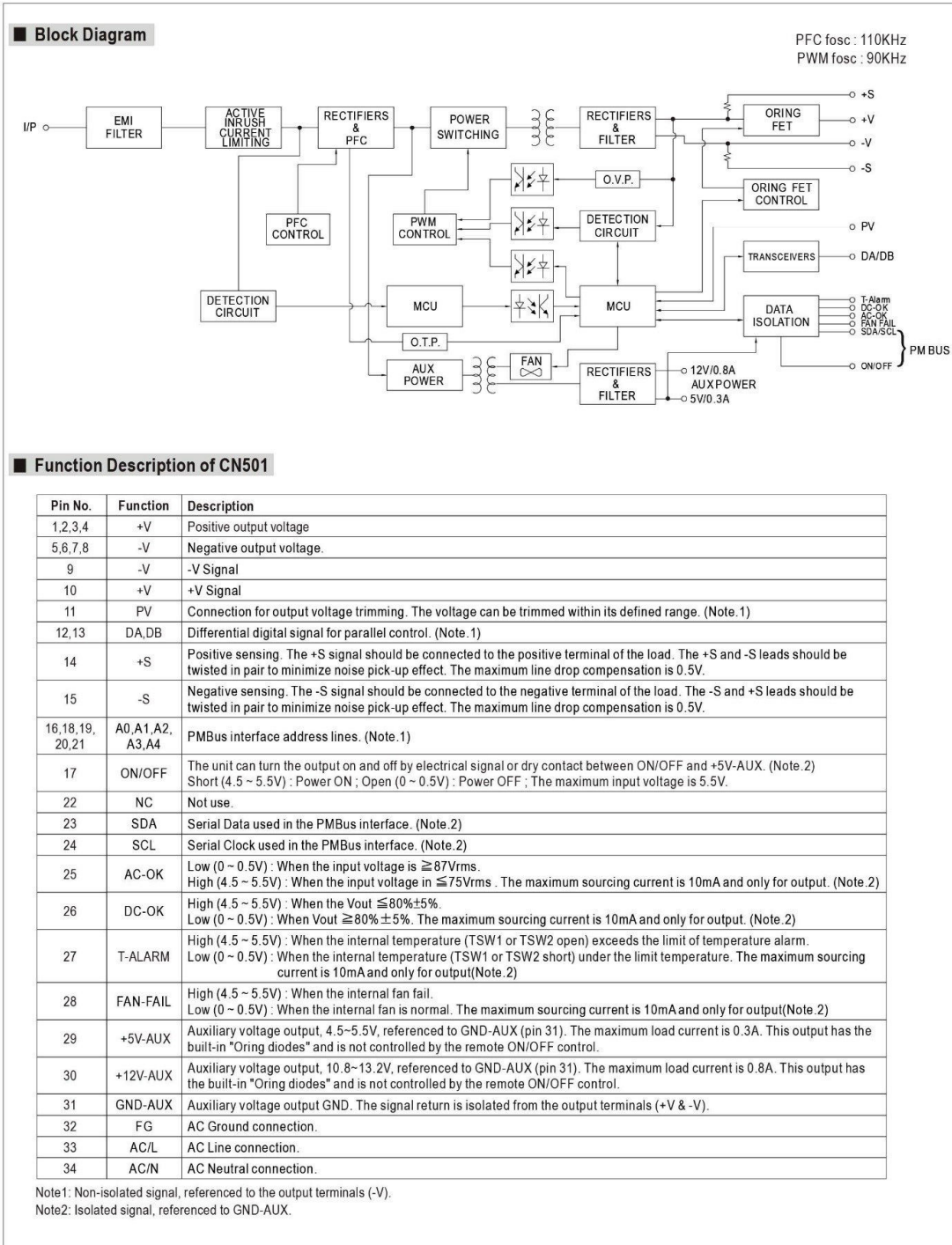

File Name:RCP-2000-SPEC 2013-11-01

SYNRAD PS-48-4000 DC Power Supply (Meanwell RKP-4K1UT-CMU1-48)



2000W Front End Power Supply

RCP-2000 series

Derating Curve

LOAD (%)

AMBIENT TEMPERATURE (°C)

Static Characteristics

LOAD (%)

INPUT VOLTAGE (VAC) 60Hz

EFFICIENCY vs LOAD (48V Model)

EFFICIENCY (%)

LOAD

DERATING LOAD(%) VS INPUT VOLTAGE

MODEL \ INPUT / VOLTAGE	>180VAC	115VAC	100VAC	90VAC
RCP-2000-12	100%	95%	90%	80%
RCP-2000-24	100%	80%	75%	65%
RCP-2000-48	100%	80%	75%	65%

Function Manual

1. Remote ON/OFF Control

The PSU can be turned ON/OFF together or separately by using the "Remote ON/OFF" function.

RCP-2000 ON/OFF 17

+5V-AUX 29

SW

Between ON/OFF and +5V-AUX	Output
SW Open	OFF
SW Short	ON

2. Voltage Drop Compensation

2.1 Remote Sense

The remote sense compensates voltage drop on the load wiring up to 0.5V.

RCP-2000 +V 14

+S 15

-S

-V

Sense lines should be twisted in pairs

LOAD +V

-V

File Name:RCP-2000-SPEC 2013-11-01

SYNRAD PS-48-4000 DC Power Supply (Meanwell RKP-4K1UT-CMU1-48)



2000W Front End Power Supply

RCP-2000 series

2.2 Local Sense

Notice : The +S,-S have to be connected to the +V,-V terminals locally in order to get the correct output voltage if the remote sensing is not used.

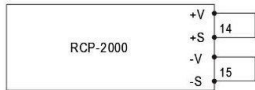

3. Output Voltage Trimming

- (1) Output voltage can be trimmed between 90~110% of its rated value by the following method.
- (2) +S & +V, -S & -V also need to be connected on CN501.

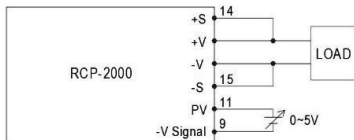

Add on 0~5V external voltage

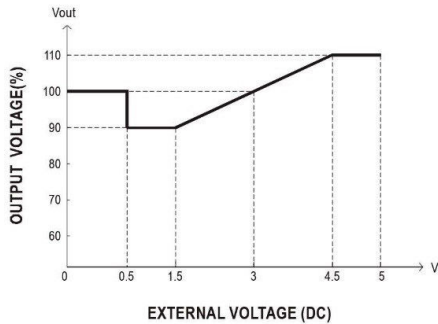

4. Front Panel Indicators & Corresponding Signal at Function Pins

Function	LED	Description	* Signal	PSU Output
AC-OK	GREEN	When input voltage $\geq 87V$	0 ~ 0.5V	ON
AC-NG	RED	When input voltage $\leq 75V$	4.5 ~ 5.5V	OFF
DC-OK	GREEN	When output voltage $\geq 80\% \pm 5\%$ of V_o rated.	0 ~ 0.5V	ON
DC-NG	RED	When output voltage $\leq 80\% \pm 5\%$ of V_o rated.	4.5 ~ 5.5V	ON
T-OK	GREEN	When the internal temperature (TSW1 & TSW2 short) is within safe limit	0 ~ 0.5V	ON
T-ALARM	RED	When the internal temperature (TSW1 or TSW2 open) exceeds the limit of temperature alarm	4.5 ~ 5.5V	OFF

*Signal between function pin and "GND-AUX".

SYNRAD

SYNRAD PS-48-4000 DC Power Supply (Meanwell RKP-4K1UT-CMU1-48)



1U Rack Control and Monitoring Unit

RKP-CMU1



■ Description :

RKP-CMU1 is a fully digitalized control / monitoring unit for the RCP-2000 power system. Equipped with USB, RS-232, and ethernet interface, it can be connected locally to PC to execute the control and monitoring tasks. With built-in 4 configurable relay contacts, users can flexibility monitor specific events or alarms and react suitable action accordingly.

■ Features :

- 1U low profile/19-inch rack mounting
- Control and monitor up to 32 RCP-2000 units
- Front panel LCD and buttons for on-site service without PC
- USB-, RS-232 or Ethernet interface for PC connection locally or remote monitoring and control via GSM modem
- Alarm/event log with time and date
- Windows-based PC communication software
- Easy wire connections on rear side
- 4 user programmable relay outputs for traditional remote monitoring or warning
- 3 years warranty

■ SELECTION GUIDE

Single unit: RKP-CMU1

Rack: RKP-1U I -CMU1

I: AC Inlet (IEC320-C20)
T: Terminal block



SPECIFICATION

MODEL	RKP-1U <input type="checkbox"/> I -CMU1	RKP-CMU1
OUTPUT	DIGITAL METER	Display the DC output voltage, current, and internal temperature of each RCP-2000 unit
	CONTROL OUTPUT	PM Bus signal for each RCP-2000 unit
	LED INDICATOR	Green: Power on Red:Alarm
	RELAY CONTACT	4 user programmable relay, relay contact rating(max.): 30V/1A resistive
INPUT	VOLTAGE RANGE <small>Note.3</small>	12 ~ 15VDC
	CURRENT	1A/12VDC 0.8A/15VDC
	MONITORING INPUTS	PM Bus signal for each RCP-2000 unit
FUNCTION	DISPLAY	LCD 16x2 Alphanumeric Matrix Display / PC Web Page Display
	MONITOR	Output Voltage / Load Current / Temperature / Input Voltage
	CONTROL	Output Voltage, Current Limit, ON/OFF
	COMM. INTERFACE	USB, RS-232, Ethernet
ENVIRONMENT	WORKING TEMP. <small>Note.1</small>	-25 ~ +70°C
	WORKING HUMIDITY	20 ~ 90% RH non-condensing
	STORAGE TEMP., HUMIDITY	-40 ~ +85°C, 10 ~ 95% RH
	VIBRATION	10 ~ 500Hz, 2G 10min./1cycle, 60min. each along X, Y, Z axes
SAFETY & EMC	SAFETY STANDARDS	UL60950-1, TUV EN60950-1 approved Design refer to TUV EN60950-1
	WITHSTAND VOLTAGE <small>Note.2</small>	I/P-O/P:3KVAC I/P-FG:2KVAC O/P-FG:0.7KVDC O/P-FG:0.7KVDC
	ISOLATION RESISTANCE <small>Note.2</small>	I/P-O/P, I/P-FG, O/P-FG:100M Ohms / 500VDC / 25°C / 70% RH O/P-FG:100M Ohms / 500VDC / 25°C / 70% RH
	EMC EMISSION	Compliance to EN55022 (CISPR22) Conduction Class B, Radiation Class A ; EN61000-3-2,-3
OTHERS	EMC IMMUNITY	Compliance to EN61000-4-2,3,4,5,6,8,11, EN61000-6-1(EN50082-2), light industry level, criteria A
	MTBF	110.5K hrs min. MIL-HDBK-217F (25°C)
OTHERS	DIMENSION	486.6*350.8*44mm (L*W*H) 147.5*127*41mm (L*W*H)
	PACKING	4.4Kg; 3pcs/14.2Kg/2.67CUFT 0.8Kg; 16pcs/13.8Kg/0.79CUFT
NOTE	1. LCD may freeze under -10°C. 2. SK100 and all of signal connectors (except CN502, CN503, and USB port) are considered as O/P. 3. Recommended use MEAN WELL power adaptor series: GS12, GS15, GS18, GE12, GE18.	

File Name:RKP-CMU1-SPEC 2012-07-24

4600 Campus Place • Mukilteo, WA 98275 • (425) 349-3500 • Fax (425) 349-3667

Rev B / Oct 19 2015 P/N 900-20975-01

SYNRAD

SYNRAD PS-48-4000 DC Power Supply (Meanwell RKP-4K1UT-CMU1-48)



1U Rack Control and Monitoring Unit

RKP-CMU1

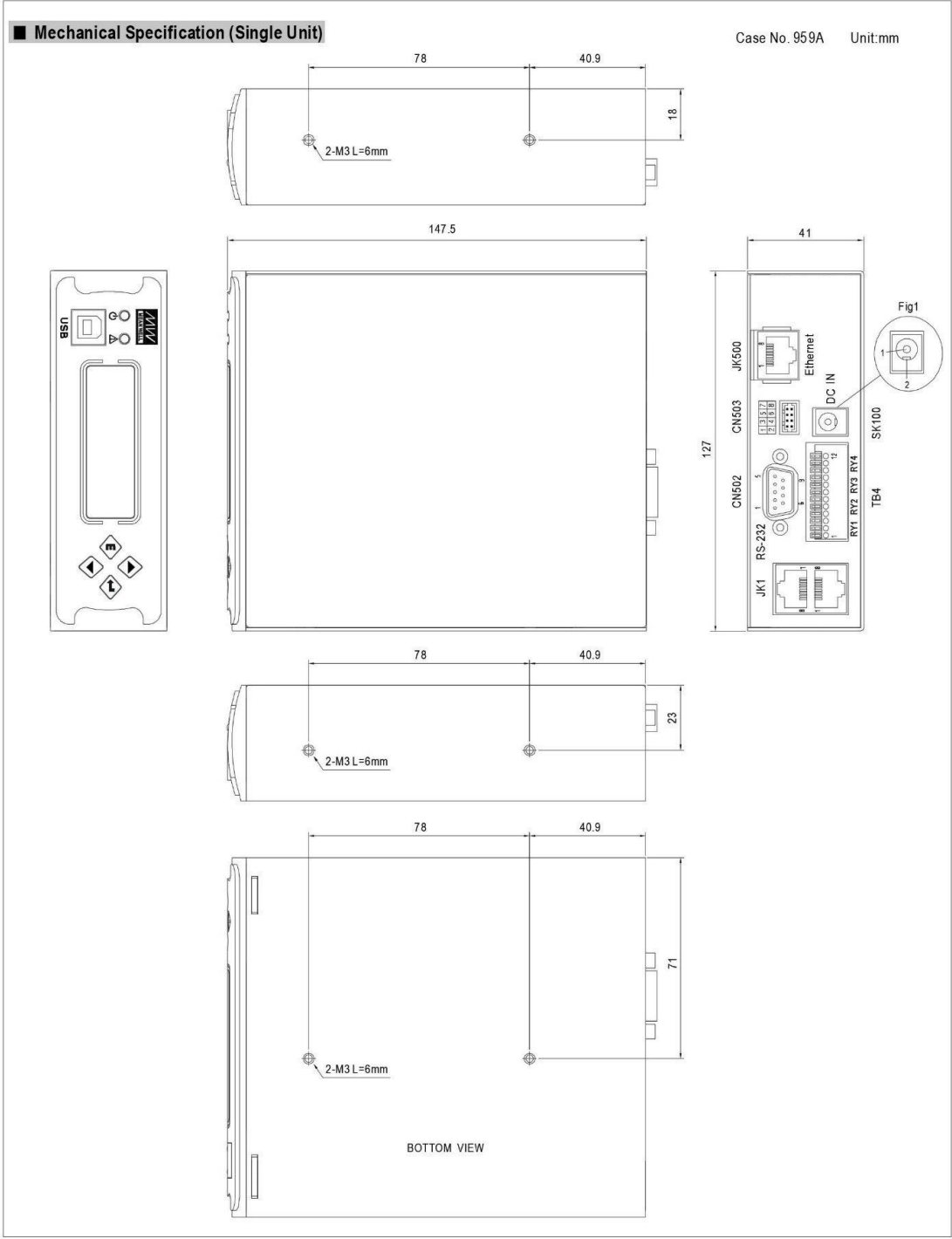

File Name:RKP-CMU1-SPEC 2012-07-24

4600 Campus Place • Mukilteo, WA 98275 • (425) 349-3500 • Fax (425) 349-3667

Rev B / Oct 19 2015 P/N 900-20975-01

SYNRAD

SYNRAD PS-48-4000 DC Power Supply (Meanwell RKP-4K1UT-CMU1-48)



1U Rack Control and Monitoring Unit

RKP-CMU1

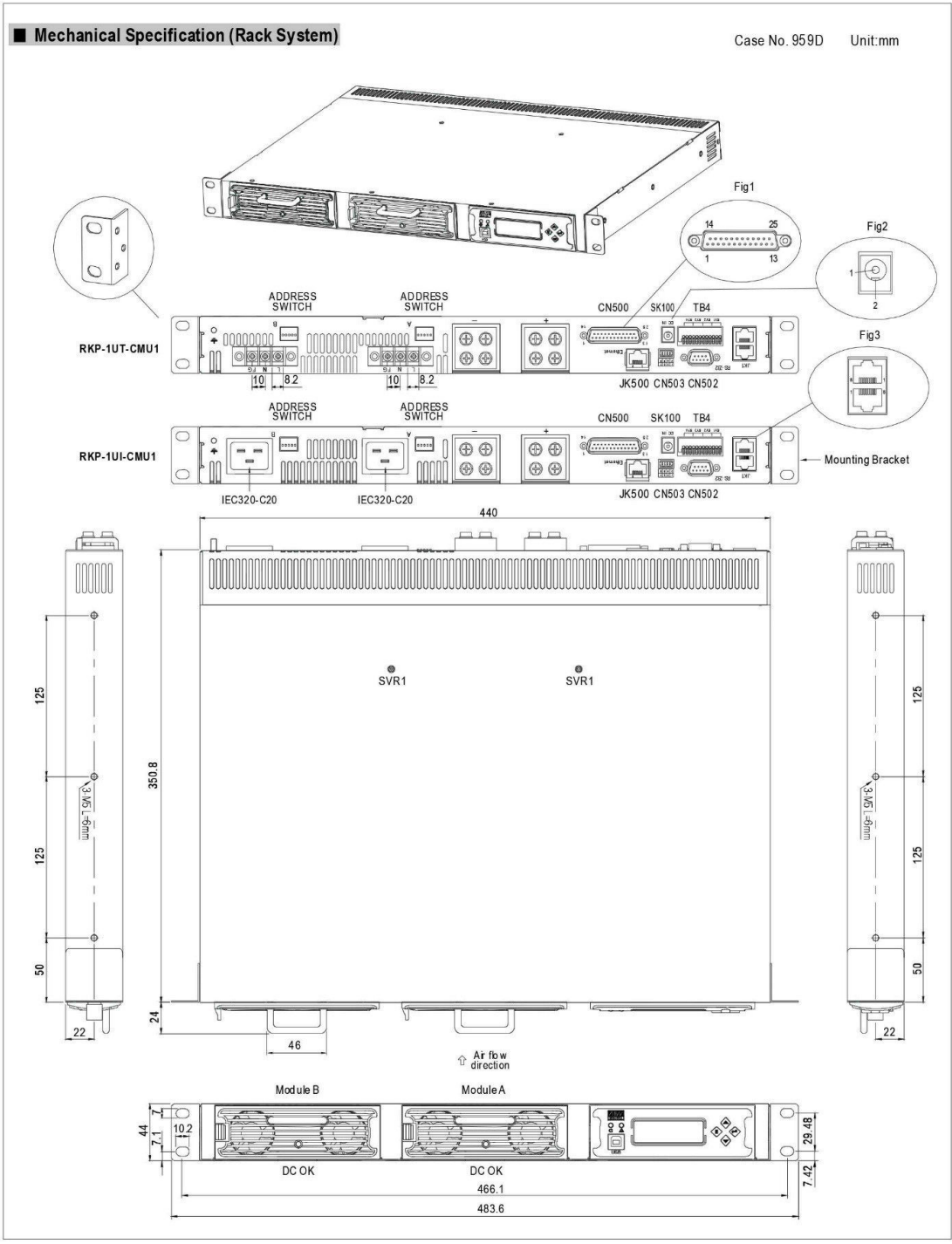

File Name:RKP-CMU1-SPEC 2012-07-24

4600 Campus Place • Mukilteo, WA 98275 • (425) 349-3500 • Fax (425) 349-3667

Rev B / Oct 19 2015 P/N 900-20975-01

SYNRAD PS-48-4000 DC Power Supply (Meanwell RKP-4K1UT-CMU1-48)



1U Rack Control and Monitoring Unit

RKP-CMU1

■ CN500 Pin No. Assignment

Connector Pin No. Assignment(CN500) : D-Type Right Angle 25 positions

Pin No.	Assignment	Pin No.	Assignment	Pin No.	Assignment	Pin No.	Assignment
1	ON/OFF-A	6	FAN FAIL-A	11	T-ALARM-B	16-21	N.C.
2	AC-OK-A	7	ON/OFF-B	12	FAN FAIL-B	22	+S
3	DC-OK-A	8	AC-OK-B	13	+5V-AUX	23	-S
4	PV-A	9	DC-OK-B	14	+12V-AUX	24	+V
5	T-ALARM-A	10	PV-B	15	GND-AUX	25	-V

■ JK1 Pin No. Assignment

Connector Pin No. Assignment(JK1) : RJ45 8 positions

Pin No.	Assignment	Pin No.	Assignment	Pin No.	Assignment
1	DA	4	CONTROL	7	SCL
2	DB	5	NC	8	GND-AUX
3	-V	6	SDA		

■ CN502 Pin No. Assignment

Connector Pin No. Assignment(CN502) : D-type Male 9 positions

Pin No.	Assignment	Pin No.	Assignment
1,4,6,7,8,9	NC	3	TXD
2	RXD	5	GND-FG

■ CN503 Pin No. Assignment

Connector Pin No. Assignment(CN503) : HRS DF11-8DP-2DS or equivalent

Pin No.	Assignment	Pin No.	Assignment
1	D-IN1	5	D-IN3
2,4,6,8	GND-FG	7	D-IN4
3	D-IN2		

■ JK500 Pin No. Assignment

Connector Pin No. Assignment(JK500) : RJ45 8 position

Pin No.	Assignment	Pin No.	Assignment
1	TX+	4,5,7,8	NC
2	TX-	6	RX-
3	RX+		

■ TB4 Pin No. Assignment

Connector Pin No. Assignment(TB4) : DECA MX422-25412 or equivalent

Pin No.	Assignment	Pin No.	Assignment	Pin No.	Assignment	Pin No.	Assignment
1	Relay1-NO	4	Relay2-NO	7	Relay3-NO	10	Relay4-NO
2	Relay1-NC	5	Relay2-NC	8	Relay3-NC	11	Relay4-NC
3	Relay1-COM	6	Relay2-COM	9	Relay3-COM	12	Relay4-COM

■ SK100 Pin No. Assignment

Connector Pin No. Assignment(SK100): Schurter 4840.2201 or equivalent

Pin No.	Assignment	Pin No.	Assignment
1	+VIN	2	-VIN

SYNRAD PS-48-4000 DC Power Supply (Meanwell RKP-4K1UT-CMU1-48)



1U Rack Control and Monitoring Unit

RKP-CMU1

■ CN500 IN/OUT Connector pins function description

Pin No.	Function	Description
1,7	ON/OFF	Each unit can separately turn the output on and off by electrical signal or dry contact between ON/OFF A,B(pin 1,7) and +5V-AUX(pin 13). Short: ON, Open:OFF. (Note.2)
2,8	AC-OK	Low : When the input voltage is $\geq 87V_{rms}$. High : when the input voltage in $\leq 75V_{rms}$. (Note.2)
3,9	DC-OK	High : When the Vout $\leq 80\pm 5\%$. Low : When Vout $\geq 80\pm 5\%$. (Note.2)
4,10	PV	Connection for output voltage trimming. The voltage can be trimmed within its defined range. (Note.1)
5,11	T-ALARM	High : When the internal temperature (TSW1 or TSW2 open) exceeds the limit of temperature alarm. Low : When the internal temperature (TSW1 or TSW2 short) under the limit temperature. (Note.2)
6,12	FAN FAIL	High : When the internal fan fail. Low : When the internal fan is normal. (Note.2)
13	+5V-AUX	Auxiliary voltage output, 4.5 ~ 5.5V, referenced to GND-AUX (pin 15). The maximum load current is 0.3A. This output has the built-in "Oring diodes" and is not controlled by the remote ON/OFF control.
14	+12V-AUX	Auxiliary voltage output, 10.8 ~ 13.2V, referenced to GND-AUX (pin 15). The maximum load current is 0.8A. This output has the built-in "Oring diodes" and is not controlled by the remote ON/OFF control.
15	GND-AUX	Auxiliary voltage output GND. The signal return is isolated from the output terminals (+V & -V).
16-21	N.C.	Not used.
22	+S	Positive sensing. The +S signal should be connected to the positive terminal of the load. The +S and -S leads should be twisted in pair to minimize noise pick-up effect. The maximum line drop compensation is 0.5V.
23	-S	Negative sensing. The -S signal should be connected to the negative terminal of the load. The -S and +S leads should be twisted in pair to minimize noise pick-up effect. The maximum line drop compensation is 0.5V.
24	+V	Positive output voltage. For local sense use only, can't be connected directly to the load.
25	-V	Negative output voltage. For local sense use only, can't be connected directly to the load.

■ JK1 IN/OUT Connector pins function description

Pin No.	Function	Description
1,2	DA,DB	Differential digital signal for parallel control. (Note.1)
3	-V	Negative output voltage. For parallel control, can't be connected directly to the load.
4	CONTROL	Remote ON/OFF control pin used in the PMBus interface. (Note.2)
5	NC	Not use.
6	SDA	Serial Data used in the PMBus interface. (Note.2)
7	SCL	Serial Clock used in the PMBus interface. (Note.2)
8	GND-AUX	Auxiliary voltage output GND. The signal return is isolated from the output terminals (+V & -V).

Note.1: Non-isolated signal, referenced to the output terminals (-V).

Note.2: Isolated signal, referenced to GND-AUX.

■ CN502 IN/OUT Connector pins function description

Pin No.	Function	Description
1,4,6,7,8,9	NC	Not used.
2	RXD	Data receiving pin of RS-232 interface.
3	TXD	Data transmitting pin of RS-232 interface.
4	GND-FG	RS-232 common GND. This signal connects to FG and isolated from -V and GND-AUX.

■ CN503 IN/OUT Connector pins function description

Pin No.	Function	Description
1,3,5,7	D-IN1 D-IN2 D-IN3 D-IN4	The isolated digital input signal and referenced to GND-FG. Open from GND-FG or +5V : Logic "1" input to RKP-CMU1 short to GND-FG or 0V : Logic "0" input to RKP-CMU1
2,4,6,8	GND-FG	Common GND for D-IN. This signal connects to FG and isolated from -V and GND-AUX.

■ JK500 IN/OUT Connector pins function description

Pin No.	Function	Description
1,2	TX+/TX-	Transmit data used in the Ethernet interface.
3,6	RX+/RX-	Receive data used in the Ethernet interface.
4,5,7,8	NC	Not used.

File Name:RKP-CMU1-SPEC 2012-07-24

SYNRAD PS-48-4000 DC Power Supply (Meanwell RKP-4K1UT-CMU1-48)



1U Rack Control and Monitoring Unit

RKP-CMU1

■ TB4 IN/OUT Connector pins function description

Pin No.	Function	Description
1,4,7,10	Relay-NO	Normal-open contact of programmable relay.
2,5,8,11	Relay-NC	Normal-close contact of programmable relay.
3,6,9,12	Relay-COM	Common for NO/NC contact.

Note: Relay contact rating (max.) : 30Vdc/1A resistive.

■ SK100 IN/OUT Connector pins function description

Pin No.	Function	Description
1	+VIN	Positive input voltage for RKP-CMU1.
2	-VIN	Negative input voltage for RKP-CMU1.

■ Function Manual

1. Communication interface

RKP-CMU1 can control and monitor RCP-2000 parameter via PMBus communication, and PC can manage the whole system by using USB, RS232, or Ethernet to connect to RKP-CMU1.

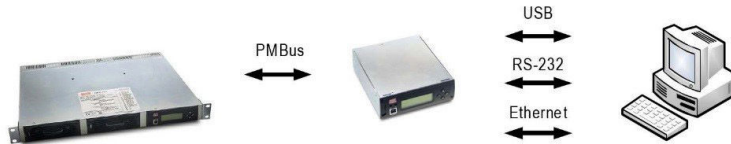

2.RCP-2000 Monitoring and control

RKP-CMU1 can monitor parameter of RCP-2000 such as output voltage, output current, internal temperature, status, serial number, and firmware version. It also can turn RCP-2000 on/off together or separately by using "ON/OFF" pin in CN500 or PMBus "CONTROL" pin in JK1 or PMBus "OPERATION" command, shows below. By using PMBus, output voltage and over load protection of RCP-2000 are adjustable.

RKP-1U ON/OFF pin	PMBus CONTROL pin	PMBus OPERATION command	RCP-2000 Output status
Connect to +5V-AUX	Open	80h (ON)	ON
Connect to +5V-AUX	Connect to +5V-AUX	80h (ON)	ON
Open	Open	80h (ON)	OFF
Open	Connect to +5V-AUX	80h (ON)	ON
Don't care	Don't care	00h (OFF)	OFF

3.Real time clock, Data Log and Event Log

RKP-CMU1 has a build-in real time clock data to display actual date/time and for log time stamp. The data logger is designed to store operating data when the systems works. It has 1000 recodes and the interval of log is programmable from 1 to 60 minutes. The event log store system condition when alarm occur and remove. There are 600 records in event log.

4.Programmable relay

There are 4 relays and each relay has normal open, normal close and common contact in terminal block. Their active conditions are programmable for flexible application, like charger and generator control, shows below.

Function	Sub-function	PSU	Parameter
Alarm	1.Any alarm 2.OVP 3.OLP 4.Short circuit 5.OTP 6.High Temperature 7.AC fail 8.Fan lock 9.PMBus error	N/A	N/A

SYNRAD PS-48-4000 DC Power Supply (Meanwell RKP-4K1UT-CMU1-48)



1U Rack Control and Monitoring Unit

RKP-CMU1

Function	Sub-function	PSU	Parameter
PSU ON	1.Immediately	PSU0~ 31	0 sec.
	2.Delay		1 ~ 600 sec.
PSU OFF	1.Immediately	PSU0~ 31	0 sec.
	2.Delay		1 ~ 600 sec.
Digital input	D-IN1 ~ D-IN4	N/A	N/A

5.PMBus communication interface

RKP-CMU1 integrates PMBus into RCP-2000 control. The supported PMBus commands are shown below.

Command Code	Command Name	Transaction Type	# of data Bytes	Description
01h	OPERATION	R/W Byte	1	Remote ON/OFF control
02h	ON_OFF_CONFIG	Read Byte	1	ON/OFF function configuration
19h	CAPABILITY	Read Byte	1	Capabilities of a PMBus device
20h	VOUT_MODE	R Byte	1	Define data format for output voltage (format: Linear, N= -9)
21h	VOUT_COMMAND	R Word	2	Output voltage setting value (format: Linear, N= -9)
22h	VOUT_TRIM	R/W Word	2	Output voltage trimming value (format: Linear, N= -9)
46h	IOUT_OC_FAULT_LIMIT	R/W Word	2	Output overcurrent setting value
47h	IOUT_OC_FAULT_RESPONSE	R Byte	1	Define protection and response when an output overcurrent fault occurred
79h	STATUS_WORD	R Word	2	Summary status reporting
7Ah	STATUS_VOUT	R Byte	1	Output voltage status reporting
7Bh	STATUS_IOUT	R Byte	1	Output current status reporting
7Ch	STATUS_INPUT	R Byte	1	AC input voltage status reporting
7Dh	STATUS_TEMPERATURE	R Byte	1	Temperature status reporting
80h	STATUS_MFR_SPECIFIC	R Byte	1	Manufacture specific status reporting
81h	STATUS_FANS_1_2	R Byte	1	Fan 1 and 2 status reporting
88h	READ_VIN	R Word	2	AC input voltage reading value (format: Linear, N= -1)
8Bh	READ_VOUT	R Word	2	Output voltage reading value (format: Linear, N= -9)
8Ch	READ_IOUT	R Word	2	Output current reading value (format: Linear, N= -3)
8Dh	READ_TEMPERATURE_1	R Word	2	Temperature 1 reading value (format: Linear, N= -3)
90h	READ_FAN_SPEED_1	R Word	2	Fan speed 1 reading value (format: Linear, N= 4)
91h	READ_FAN_SPEED_2	R Word	2	Fan speed 2 reading value (format: Linear, N= 4)
98h	PMBUS_REVISION	R Byte	1	The compliant revision of the PMBus (default: 11h for Rev. 1.1)
99h	MFR_ID	Block Read	12	Manufacturer's name
9Ah	MFR_MODEL	Block Read	12	Manufacturer's model name
9Bh	MFR_REVISION	Block Read	6	Firmware revision
9Ch	MFR_LOCATION	Block R/W	3	Manufacturer's factory location
9Dh	MFR_DATE	Block R/W	6	Manufacture date. (format: YYMMDD)
9Eh	MFR_SERIAL	Block R/W	12	Product serial number

File Name:RKP-CMU1-SPEC 2012-07-24